

# TASCAM

D01167920A

# CD-9010

## CD Player

### OWNER'S MANUAL

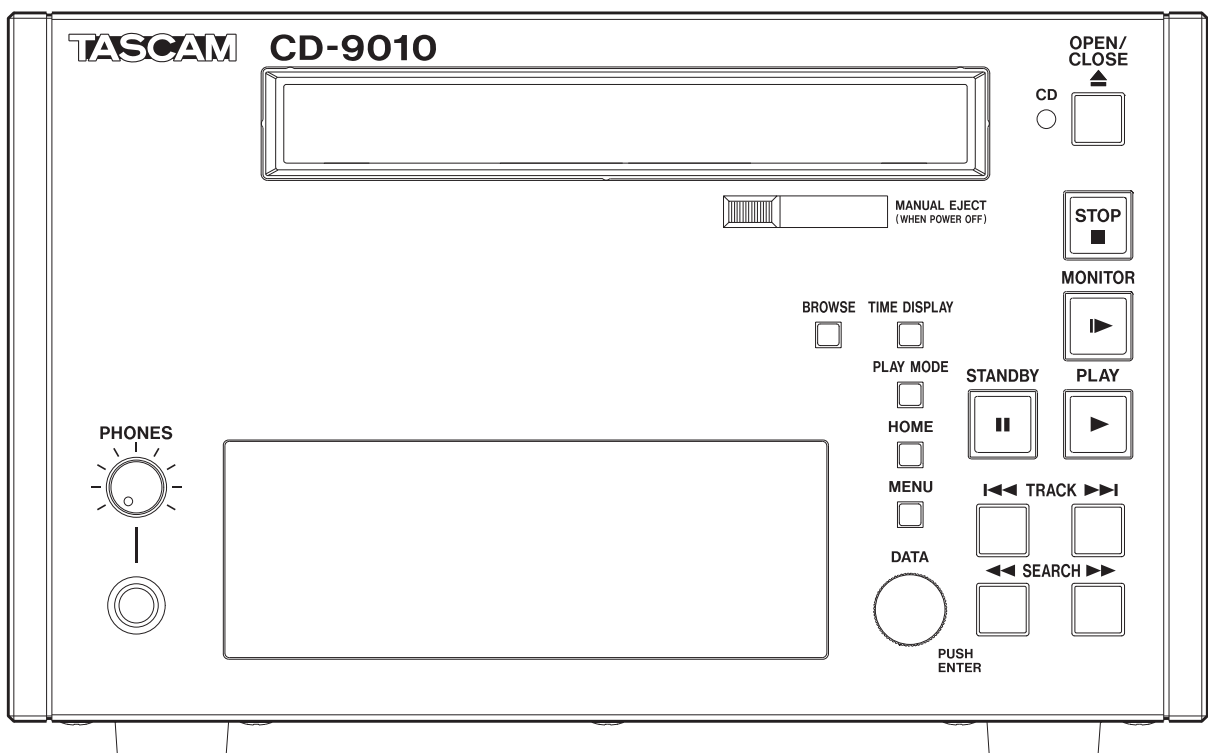

# Important Safety Information



**CAUTION**  
RISK OF ELECTRIC SHOCK  
DO NOT OPEN



**CAUTION:** TO REDUCE THE RISK OF ELECTRIC SHOCK, DO NOT REMOVE COVER (OR BACK). NO USER-SERVICEABLE PARTS INSIDE. REFER SERVICING TO QUALIFIED SERVICE PERSONNEL.



The lightning flash with arrowhead symbol, within equilateral triangle, is intended to alert the user to the presence of uninsulated "dangerous voltage" within the product's enclosure that may be of sufficient magnitude to constitute a risk of electric shock to persons.



The exclamation point within an equilateral triangle is intended to alert the user to the presence of important operating and maintenance (servicing) instructions in the literature accompanying the appliance.

**WARNING: TO PREVENT FIRE OR SHOCK HAZARD, DO NOT EXPOSE THIS APPLIANCE TO RAIN OR MOISTURE.**

- 1 Read these instructions.
- 2 Keep these instructions.
- 3 Heed all warnings.
- 4 Follow all instructions.
- 5 Do not use this apparatus near water.
- 6 Clean only with dry cloth.
- 7 Do not block any ventilation openings. Install in accordance with the manufacturer's instructions.
- 8 Do not install near any heat sources such as radiators, heat registers, stoves, or other apparatus (including amplifiers) that produce heat.
- 9 Do not defeat the safety purpose of the polarized or grounding-type plug. A polarized plug has two blades with one wider than the other. A grounding type plug has two blades and a third grounding prong. The wide blade or the third prong are provided for your safety. If the provided plug does not fit into your outlet, consult an electrician for replacement of the obsolete outlet.
- 10 Protect the power cord from being walked on or pinched particularly at plugs, convenience receptacles, and the point where they exit from the apparatus.
- 11 Only use attachments/accessories specified by the manufacturer.

- 12 Use only with the cart, stand, tripod, bracket, or table specified by the manufacturer, or sold with the apparatus. When a cart is used, use caution when moving the cart/apparatus combination to avoid injury from tip-over.



- 13 Unplug this apparatus during lightning storms or when unused for long periods of time.
- 14 Refer all servicing to qualified service personnel. Servicing is required when the apparatus has been damaged in any way, such as power-supply cord or plug is damaged, liquid has been spilled or objects have fallen into the apparatus, the apparatus has been exposed to rain or moisture, does not operate normally, or has been dropped.
  - The apparatus draws nominal non-operating power from the AC outlet with its POWER or STANDBY/ON switch not in the ON position.
  - The mains plug is used as the disconnect device, the disconnect device shall remain readily operable.
  - Caution should be taken when using earphones or headphones with the product because excessive sound pressure (volume) from earphones or headphones can cause hearing loss.
  - If you are experiencing problems with this product, contact TEAC for a service referral. Do not use the product until it has been repaired.

## CAUTION

- Do not expose this apparatus to drips or splashes.
- Do not place any objects filled with liquids, such as vases, on the apparatus.
- Do not install this apparatus in a confined space such as a book case or similar unit.
- The apparatus should be located close enough to the AC outlet so that you can easily grasp the power cord plug at any time.
- If the product uses batteries (including a battery pack or installed batteries), they should not be exposed to sunshine, fire or excessive heat.
- CAUTION for products that use replaceable lithium batteries: there is danger of explosion if a battery is replaced with an incorrect type of battery. Replace only with the same or equivalent type.

## WARNING

Products with Class I construction are equipped with a power supply cord that has a grounding plug. The cord of such a product must be plugged into an AC outlet that has a protective grounding connection.

In North America use only on 120V supply.

## ■ For U.S.A.

### TO THE USER

This equipment has been tested and found to comply with the limits for a Class A digital device, pursuant to Part 15 of the FCC Rules. These limits are designed to provide reasonable protection against harmful interference when the equipment is operated in a commercial environment. This equipment generates, uses, and can radiate radio frequency energy and, if not installed and used in accordance with the instruction manual, may cause harmful interference to radio communications.

Operation of this equipment in a residential area is likely to cause harmful interference in which case the user will be required to correct the interference at his own expense.

### CAUTION

Changes or modifications to this equipment not expressly approved by TEAC CORPORATION for compliance could void the user's authority to operate this equipment.

## ■ For European Customers

### CE Marking Information

- a) Applicable electromagnetic environment: E4
- b) Peak inrush current: 14 A

### Disposal of electrical and electronic equipment

- (a) All electrical and electronic equipment should be disposed of separately from the municipal waste stream via collection facilities designated by the government or local authorities.
- (b) By disposing of electrical and electronic equipment correctly, you will help save valuable resources and prevent any potential negative effects on human health and the environment.
- (c) Improper disposal of waste electrical and electronic equipment can have serious effects on the environment and human health because of the presence of hazardous substances in the equipment.
- (d) The Waste Electrical and Electronic Equipment (WEEE) symbol, which shows a wheeled bin that has been crossed out, indicates that electrical and electronic equipment must be collected and disposed of separately from household waste.



- (e) Return and collection systems are available to end users. For more detailed information about the disposal of old electrical and electronic equipment, please contact your city office, waste disposal service or the shop where you purchased the equipment.

### Disposal of batteries and/or accumulators

- (a) Waste batteries and/or accumulators should be disposed of separately from the municipal waste stream via collection facilities designated by the government or local authorities.
- (b) By disposing of waste batteries and/or accumulators correctly, you will help save valuable resources and prevent any potential negative effects on human health and the environment.
- (c) Improper disposal of waste batteries and/or accumulators can have serious effects on the environment and human health because of the presence of hazardous substances in them.
- (d) The WEEE symbol, which shows a wheeled bin that has been crossed out, indicates that batteries and/or accumulators must be collected and disposed of separately from household waste.



Pb, Hg, Cd

If a battery or accumulator contains more than the specified values of lead (Pb), mercury (Hg), and/or cadmium (Cd) as defined in the Battery Directive (2006/66/EC), then the chemical symbols for those elements will be indicated beneath the WEEE symbol.

- (e) Return and collection systems are available to end users. For more detailed information about the disposal of waste batteries and/or accumulators, please contact your city office, waste disposal service or the shop where you purchased them.

### WARNING

This is a Class A product. In a domestic environment, this product may cause radio interference in which case the user may be required to take adequate measures.

### For Canada

THIS CLASS A DIGITAL APPARATUS COMPLIES WITH CANADIAN ICES-003.CET

APPAREIL NUMERIQUE DE LA CLASSE B EST CONFORME A LA NORME NMB-003 DU CANADA.

# Safety precautions

## ■ CAUTIONS ABOUT LASER RADIATION

This product has been designed and manufactured according to FDA regulations "title 21, CFR, chapter 1, subchapter J, based on the Radiation Control for Health and Safety Act of 1968," and is classified as a class 1 laser product. There is no hazardous invisible laser radiation during operation because invisible laser radiation emitted inside of this product is completely confined in the protective housings.

The label required in this regulation is shown at ①.

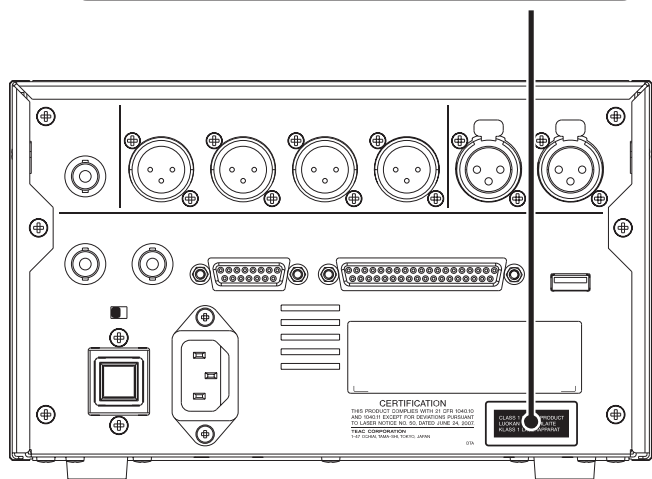
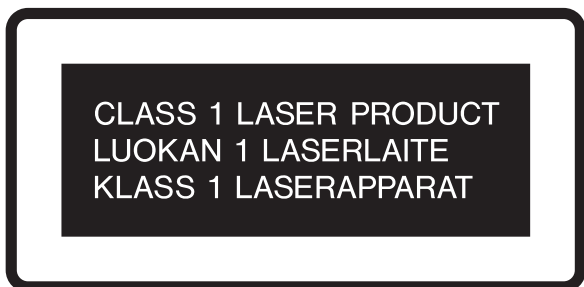

## CAUTIONS

- DO NOT REMOVE THE PROTECTIVE HOUSING USING A SCREWDRIVER.
- USE OF CONTROLS OR ADJUSTMENTS OR PERFORMANCE OF PROCEDURES OTHER THAN THOSE SPECIFIED HEREIN MAY RESULT IN HAZARDOUS RADIATION EXPOSURE.
- IF THIS PRODUCT DEVELOPS TROUBLE, CONTACT YOUR NEAREST QUALIFIED SERVICE PERSONNEL, AND DO NOT USE THE PRODUCT IN ITS DAMAGED STATE.

### Optical pickup

Type: HOF-1501XB  
 Manufacturer: Hitachi Media Electronics  
 Laser output: Less than 0.5 mW on the objective lens  
 Wavelength: 785 nm ±22 nm  
 Standard: IEC60825-1 : 2007

This appliance has a serial number located on the rear panel. Please record the model number and serial number and retain them for your records.

**Model number**

\_\_\_\_\_

**Serial number**

\_\_\_\_\_

## 产品有毒有害物质或元素的名称及含量

机种: CD-9010		有毒有害物质或元素				
品名	铅 (Pb)	汞 (Hg)	镉 (Cd)	六价铬 (Cr6+)	多溴联苯 (PBB)	多溴二苯醚 (PBDE)
1 CHASSIS 部份	○	○	○	○	○	○
2 PCB Assy 部份	×	○	○	○	○	○
3 CD DRIVE 部份	○	○	○	○	○	○
4 线材部份	○	○	○	○	○	○
5 附属品部份	○	○	○	○	○	○
6 LABEL 部份	○	○	○	○	○	○
7 包装部份	○	○	○	○	○	○

○: 表示该有毒有害物质在该部件所有均质材料中的含有量均在 SJ/T11363-2006 标准规定的限量要求以下。

×: 表示该有毒有害物质至少在该部件的某一均质材料中的含量超出 SJ/T11363-2006 标准规定的限量要求。

(针对现在代替技术困难的电子部品及合金中的铅)

<b>1 – Introduction</b> .....	6
Features .....	6
Included items .....	6
Conventions used in this manual .....	6
Intellectual property rights .....	7
Precautions for placement and use.....	7
Connecting the power .....	7
Beware of condensation.....	7
Cleaning the unit.....	7
About discs.....	7
Handling of compact discs .....	7
<b>2 – Names and Functions of Parts</b> .....	8
Front panel .....	8
Rear panel .....	10
Home Screen .....	11
Menu structure .....	12
Menu operation basics .....	13
Menu operation procedures.....	13
<b>3 – Preparations</b> .....	14
Turning the power ON and OFF.....	14
Turning the power OFF .....	14
Adjusting the display.....	14
Adjusting display contrast .....	14
Adjusting display and indicator brightness.....	15
Connecting headphones .....	15
Setting the panel lock function .....	16
<b>4 – Playback</b> .....	17
Monitoring and online playback.....	17
Monitoring playback.....	17
Online playback.....	17
Setting the playback mode .....	17
Playing a track once from the beginning .....	18
Playing a track from the middle.....	18
Automatic cue point memory (last cue) .....	18
Setting the playback point.....	19
Selecting tracks.....	19
Operation after selection of a track.....	19
Searching within tracks.....	19
Auto cue function .....	19
Auto ready function.....	20
Incremental playback function .....	20
ONLINE BACK CUE function .....	20
PLAY KEY FUNCTION setting .....	20
MONITOR PLAY STBY function .....	21
ONLINE PLAY STBY function .....	21
Repeat playback.....	21
Ordinary repeat playback .....	21
EOM functions.....	22
Setting EOM tally output trigger .....	22
How to use the EOM .....	22
Checking the ends of tracks.....	22
Setting the amount of time checked .....	22
How to use the end check function .....	22
Pitch control playback.....	23
Turning pitch control playback ON/OFF .....	23
Setting the pitch control value .....	23
PITCH/TIME FIT function.....	23
<b>5 – Program and cue playback</b> .....	24
Program playback.....	24
Program menu operation .....	24
Adding tracks to a program .....	24
Clearing a program.....	25
Removing tracks from a program .....	25
Moving tracks within a program .....	25
Cue point playback.....	26
Using the cue menu .....	26
Adding cue points .....	26
Clearing the cue list.....	26
Clearing a cue point .....	26
Editing cue point names.....	27
Editing text .....	27
Automatic cue point loading options .....	27
<b>6 – Working with files and folders</b> .....	28
Opening the BROWSE screen .....	28
Navigating the BROWSE screen .....	28
Icons on the BROWSE screen.....	28
Folder operations.....	28
File and folders on data CDs .....	28
<b>7 – Other settings and information display</b> .....	29
Setting the digital reference level.....	29
Setting the analog reference level .....	29
Adjusting R/L analog reference levels.....	29
Setting the online function.....	29
Master clock and digital output combinations.....	30
Setting the master word clock.....	30
Mono mix setting.....	30
Fail safe function setting.....	31
Setting the level meter display type.....	31
Monitoring point setting.....	31
Muting monitoring when online.....	31
Restoring the factory settings.....	32
Setting the digital output format .....	32
Viewing media information .....	32
Viewing system information.....	32
<b>8 – Using the remote connectors</b> .....	33
Using the serial connector .....	33
Fader use setting.....	33
Fader start function setting.....	33
Fader stop function setting .....	33
Fader stop action setting .....	34
Setting the fader scale used.....	34
Transmission speed setting.....	34
Using the parallel connector .....	35
Parallel port 3-pin/13-pin setting.....	35
<b>9 – Message list</b> .....	36
Error messages.....	36
Warning messages .....	36
Operation messages.....	36
<b>10 – Troubleshooting</b> .....	37
<b>11 – Specifications</b> .....	38
Media and file formats .....	38
Inputs and outputs.....	38
Analog audio inputs and outputs.....	38
Digital audio output.....	38
Control inputs and outputs .....	38
Audio performance.....	38
Backup memory .....	39
General .....	39
Dimensional drawings .....	39

# 1 – Introduction

Thank you very much for purchasing a TASCAM CD-9010 CD Player.

Please read this manual thoroughly before using the unit so that you understand correct operating procedures and can use its functions fully. We hope that you enjoy using this unit for many years.

Please keep this manual so that you can refer to it at any time. A digital copy of this manual can also be downloaded from our website (<http://tascam.com/>).

---

## Features

---

This professional CD player is designed for a variety of uses, including broadcasting, postproduction and installation applications. Here are some of its features.

- In addition to commercially-available audio CDs, CD-DA format audio CDs and CD-R discs with WAV format files (except unfinalized data CDs) can be played back
- Analog inputs: **MIX INPUTS** stereo pair (signal can mixed with the CD playback signal or passed through as is to the **LINE OUTPUTS**)
- Analog outputs: **LINE OUTPUTS** stereo pair, **MONITOR OUTPUTS** stereo pair and stereo **PHONES** monitoring output
- Digital output: 2 outputs (stereo) with sample rate conversion
- Playback signals of the two playback modes—online playback for live/on-air use and monitoring playback for confirmation/rehearsal use—can be output from different connectors
- Auto cue function enables standby at the point when audio begins in a track
- Auto ready function enables automatic standby at the beginning of the next track after one track completes playback
- **JOG** dial enables searching one frame at a time
- Searching by index is possible
- Fail safe function prevents misoperation during critical playback situations
- Synchronization with external word clock (44.1 or 48 kHz) is possible and the CD playback signal can be output digitally with a 48kHz sampling frequency when synchronized with 48kHz external clock
- $\pm 12.5\%$  pitch control function
- Connect a TASCAM RC-9010/RC-9010S remote control (sold separately) to enhance operation and increase functionality
- End check function allows playback of the ends of tracks
- Up to 9 cue points can be remembered for each disc
- Manual eject mechanism allows CDs to be removed even when the power is off

---

## Included items

---

This product includes the following items.

Take care when opening the package not to damage the items. Keep the packing materials for transportation in the future.

Please contact TASCAM if any of these items are missing or have been damaged during transportation.

- Main unit ..... 1
- Power cord ..... 1
- Warranty card ..... 1
- Owner's Manual (this manual) ..... 1

---

## Conventions used in this manual

---

In this manual, we use the following conventions:

- When instructed to select an item, use the controls so that item appears to be light letters on a dark background.
- Buttons, connectors and other parts of the unit and external devices are indicated like this: **STOP**
- Messages on the unit's display are shown like this: MENU
- CD-DA format discs are sometimes called "audio CDs"
- A CD with WAV files is sometimes called a "data CD"
- Additional information is provided as necessary as tips, notes and cautions.

### TIP

*These are tips about how to use the unit.*

### NOTE

*These provide additional explanations and describe special cases.*

### CAUTION

*Failure to follow these instructions could result in injury, damage to equipment or lost recording data, for example.*

---

## Intellectual property rights

---

- TASCAM is a trademark of TEAC Corporation, registered in the U.S. and other countries.
- Other company names, product names and logos in this document are the trademarks or registered trademarks of their respective owners.

---

## Precautions for placement and use

---

- The operating temperature should be between 5°C and 35°C (41°F and 95°F).
- Do not install in the following types of places. Doing so could degrade the sound quality and/or cause malfunctions.
  - Places with significant vibrations or that are otherwise unstable
  - Near windows or other places exposed to direct sunlight
  - Near heaters or other extremely hot places
  - Extremely cold places
  - Places with bad ventilation or high humidity
  - Very dusty locations
- This unit can be installed at an angle of  $\pm 5^\circ$ .
- In order to assure good heat dissipation, do not place any object on top of the unit.
- Do not install this unit on top of any heat-generating electrical device such as a power amplifier.

---

## Connecting the power

---

- Insert the included power cord into the **AC IN** connector completely.
- Hold the power cord by the plug when connecting or disconnecting it.

---

## Beware of condensation

---

If the unit is moved from a cold to a warm place, or used immediately after a cold room has been heated or otherwise exposed to a sudden temperature change, condensation could occur. Should this happen, leave the unit for one or two hours before turning the unit on.

---

## Cleaning the unit

---

To clean the unit, wipe it gently with a soft dry cloth. Do not wipe with chemical cleaning cloths, benzene, paint thinner, ethyl alcohol or other chemical agents to clean the unit as they could damage the surface.

---

## About discs

---

In addition to commercially-available music CDs, this unit can play CD-R discs that have been recorded in audio CD (CD-DA) format, as well as CD-R discs that have WAV audio files recorded on them. It can also playback 8cm discs.

---

## Handling of compact discs

---

- Always load compact discs with their labels facing upward.
- To remove a disc from its case, press down on the center of the disc holder, then lift the disc out, holding it carefully by the edges.
- Do not touch the signal side (the unlabeled side). Fingerprints, oils and other substances can cause errors during playback.
- To clean the signal side of a disc, wipe gently with a soft dry cloth from the center towards the outside edge. Dirt on discs can lower the sound quality, so clean them and always store them in a clean state.
- Do not use any record spray, anti-static solutions, benzene, paint thinner or other chemical agents to clean CDs as they could damage the delicate playing surface. It may cause CDs to become unplayable.
- Do not apply labels or other materials to discs. Do not use discs that have had tape, stickers or other materials applied to their surface. Do not use discs that have sticky residue from stickers, etc. Such discs could become stuck in the unit or cause it to malfunction.
- Never use a commercially available CD stabilizer. Using stabilizers with this player will damage the mechanism and cause it to malfunction.
- Do not use cracked discs.
- Only use circular compact discs. Avoid using non-circular promotional discs, etc.

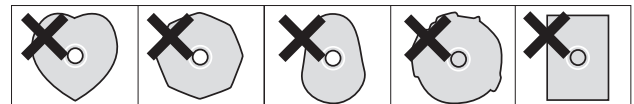

- Music discs with copy control, a copy-protection system, have been released from several record companies in an attempt to protect the copyright. Since some of these discs do not comply with the CD specifications, they may not be playable on the unit.

# 2 – Names and Functions of Parts

## Front panel

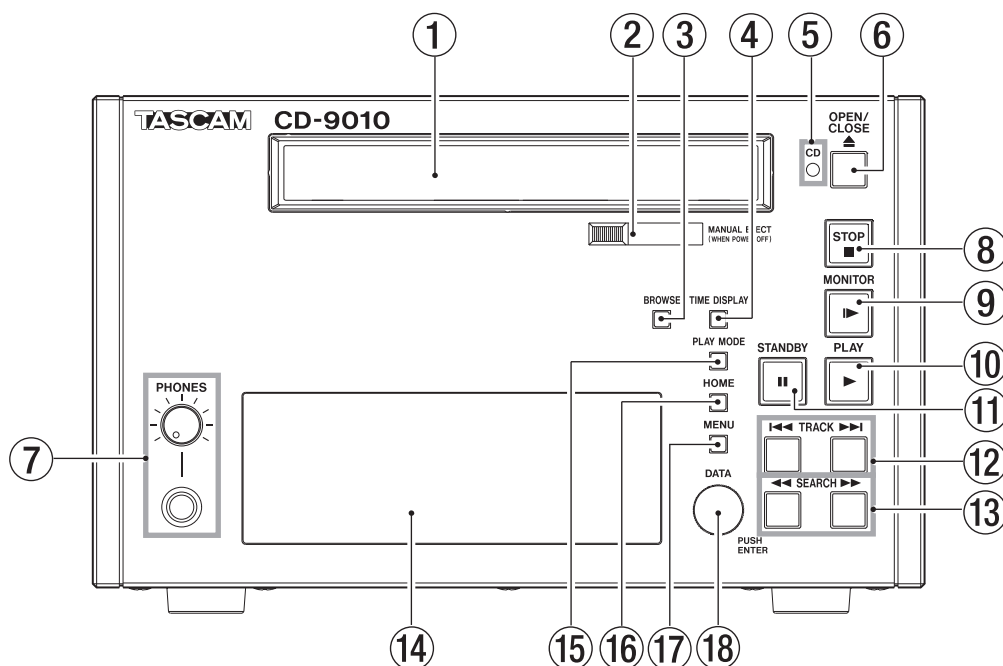

- ① **Disc tray**  
Press the **OPEN/CLOSE** button to open the disc tray to load or remove discs.  
Press the **OPEN/CLOSE** button again to close the disc tray.
- ② **MANUAL EJECT**  
Use this to remove a disc when the power is off.
- ③ **BROWSE button**  
Press to open the **BROWSE** screen.  
Use this screen to look inside folders on data CDs, for example.  
With audio CDs, use the screen to see its tracks.
- ④ **TIME DISPLAY button**  
Press when the Home Screen is open to switch the time display between elapsed track time and remaining track time. This button only changes the display on this unit.  
To change the time display on a connected TASCAM RC-9010/RC-9010S remote control (sold separately), press the **TIME DISPLAY** button on the remote.  
When the Home Screen is open, press and hold this button while turning the **DATA** dial to adjust the display contrast.

### NOTE

*This operation only adjusts the contrast of this unit. It does not adjust the contrast of a connected TASCAM RC-9010/RC-9010S remote control (sold separately).*

- ⑤ **CD indicator**  
This blinks when a CD is loaded. When data reading is complete, the indicator stays lit and playback is possible.
- ⑥ **OPEN/CLOSE button**  
Press this to open the disc tray.

### NOTE

*In order to reduce the amount of time required to remove a disc, the disc tray will open before the disc has completely stopped.*

- ⑦ **PHONES jack/knob**  
Use this standard stereo jack to connect stereo headphones.  
Use the **PHONES** knob to adjust the headphones output level.  
The knob can be pushed in and locked, allowing the unit to be stored and transported safely. To unlock it, push it in again. (See "Connecting headphones" on page 15.)

### CAUTION

*Before connecting headphones, use the PHONES knob to lower the volume. Failure to do so might result in sudden loud sounds, which could harm your hearing or result in other trouble.*

- ⑧ **STOP button/indicator**  
Press this button at any time to stop playback at the current point.  
Press this button during online or monitoring playback or when in playback standby to stop playback.  
This button lights when playback is stopped.
- ⑨ **MONITOR button/indicator**  
Press this button to start monitoring playback.  
The playback signal is output through the **MONITOR OUTPUTS (R/L)** and the **PHONES** jack.  
This button lights during monitoring playback.
- ⑩ **PLAY button/indicator**  
Press when playback is stopped or in standby to start playback. This button lights during playback or when in playback standby.  
When the **ON LINE** button on a connected TASCAM RC-9010/RC-9010S remote control (sold separately) is lit, or the **SYSTEM** menu **ONLINE FUNCTION** item is set to **ALWAYS ON**, online playback occurs and the playback signal is output through the **LINE OUTPUTS (R/L)** and the **DIGITAL OUTPUT**.  
To send the signal through the **MONITOR OUTPUTS (R/L)** and **PHONES** jack, set the **SYSTEM** menu **MON MUTE ONLINE** item to **OFF**. (See "Muting monitoring when online" on page 31.)  
This button lights during online playback.



## 2 – Names and Functions of Parts

### 11 STANDBY button/indicator

When playback is stopped or during jog playback, press this button to pause and start playback standby at the current point.

When in monitoring playback mode and MONITOR PLAY STBY is set to BACK CUE in the PLAY menu, press this button to return to the point at which monitoring playback last started and enter standby. When MONITOR PLAY STBY is set to NORMAL, press to enter playback standby at the current point.

When using online playback, pressing this button has a different function depending on the playback mode.

Playback mode	Function
CONTINUE or SINGLE	When ONLINE PLAY STBY is set to NORMAL in the PLAY menu, enter playback standby at the current position. When set to BACK CUE, locate to the last cue point and enter playback standby.
PROGRAM	When ONLINE PLAY STBY is set to NORMAL in the PLAY menu, enter playback standby at the beginning of the next track. When set to BACK CUE, locate to the last cue point and enter playback standby.

This button lights when in playback standby.

### 12 TRACK ◀◀/▶▶ buttons

Use these buttons to skip between and select tracks.

### 13 SEARCH ◀◀/▶▶ buttons

Search while pressing these buttons.

While pressing the SEARCH ▶▶ (or SEARCH ◀◀) button to search, you can change the search speed by pressing the other SEARCH ◀◀/▶▶ button.

### 14 Display

This shows disc information, the operation mode, menus and other data.

### 15 PLAY MODE button

When the Home Screen is open, press this button to cycle through the playback modes in the following order.

→ CONTINUE mode → SINGLE mode → PROGRAM mode →

### 16 HOME button

When the MENU screen, BROWSE screen, PROGRAM screen or CUE LIST screen is open, press this to return to the Home Screen.

Press this button when the Home Screen is open to scroll CD-TEXT file names and data in the information area of the Home Screen.

Press the MENU button while pressing and holding this button to turn the panel lock function ON and OFF. (See "Setting the panel lock function" on page 16.)

When the Home Screen is open, press and hold this button while turning the DATA dial to adjust the brightness of the display and the indicators.

You can adjust the brightness of the display alone by pressing and turning the DATA dial while pressing and holding this button.

#### NOTE

*This operation only adjusts the contrast of the display and indicators of this unit. It does not adjust the contrast of a connected TASCAM RC-9010/RC-9010S remote control (sold separately).*

### 17 MENU button

Press to open the MENU screen.

Press this button while pressing and holding the HOME button to turn the panel lock function ON and OFF. (See "Setting the panel lock function" on page 16.)

### 18 DATA dial

Turn the DATA dial to select items on the MENU screen.

Press the dial to use it as an ENTER button when confirming operations on the MENU screen.

When the Home Screen is open, press and hold the HOME button while turning the dial to adjust the brightness of the display and the indicators.

To adjust the brightness of the display alone, press and turn this dial while pressing and holding the HOME button.

Press and hold the TIME DISPLAY button while turning the DATA dial to adjust the display contrast.

#### NOTE

*These operations only adjust the brightness and contrast of the display and indicators of this unit. They do not adjust the brightness and contrast of a connected TASCAM RC-9010/RC-9010S remote control (sold separately).*

## 2 – Names and Functions of Parts

### Rear panel

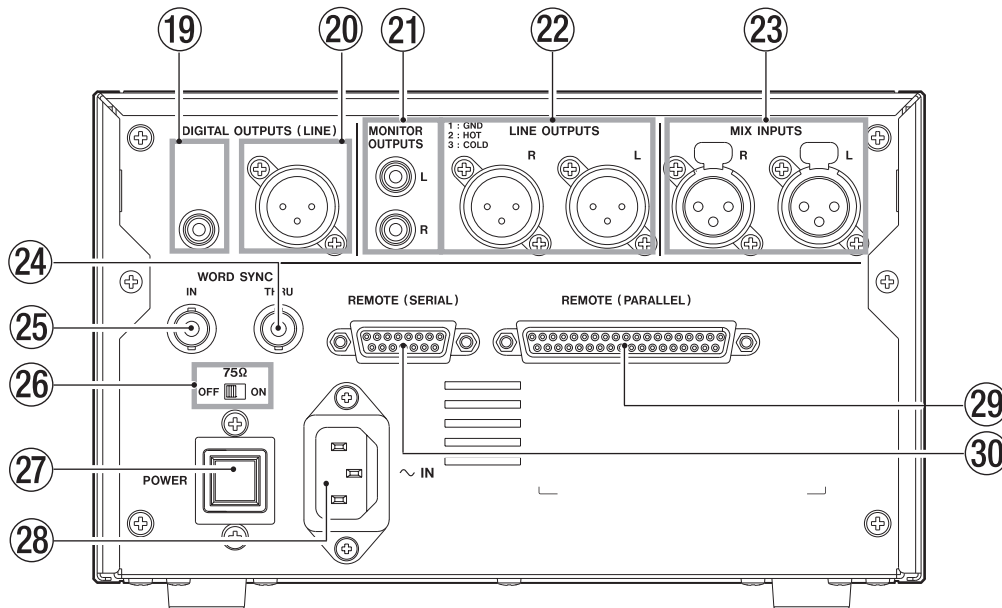

#### 19 DIGITAL OUTPUT (COAXIAL)

This outputs a digital CD playback signal. The digital output signal depends on the **DIGITAL OUT TYPE** setting on the **SYSTEM** menu screen. (See "Setting the digital output format" on page 29.)

The digital output signal depends on the master clock setting. (See "Setting the master word clock" on page 30.)

#### 20 DIGITAL OUTPUT (XLR)

This outputs a digital CD playback signal. The digital output signal depends on the **DIGITAL OUT TYPE** setting on the **SYSTEM** menu screen. (See "Setting the digital output format" on page 29.)

The digital output signal depends on the master clock setting. (See "Setting the master word clock" on page 30.)

#### 21 MONITOR OUTPUTS (R/L) (unbalanced)

These unbalanced RCA analog outputs can be connected to a monitoring system.

The nominal output level is  $-10$  dBv.

#### 22 LINE OUT OUTPUTS (R/L) (balanced)

These are balanced analog XLR outputs.

The default nominal output level is  $+4$  dBu ( $+6$  dBu only when the maximum output level is  $+15$  dBu), but can be set to  $-20$  dBu.

(1: GND, 2: HOT, 3: COLD)

#### 23 MIX INPUTS (R/L) (balanced)

These balanced analog XLR inputs are used for mix input with a nominal output level of  $+4$  dBu.

(1: GND, 2: HOT, 3: COLD)

Signals input here are mixed with the playback signal from the CD and output from the **LINE OUTPUTS**. Even when the power is off, signals input here will be output unchanged through the **LINE OUTPUTS**.

#### 24 WORD SYNC THRU

The input word clock signal is thru output from this connector, allowing it to be sent to other digital devices.

#### 25 WORD SYNC IN

Input a word clock signal through this connector. When this unit is set to use an external clock (EXT), the word clock input through this connector is used.

#### 26 75Ω (ON/OFF) switch

Turns the  $75\Omega$  word clock terminator ON or OFF.

#### 27 POWER switch

Turns the power ON or OFF.

### CAUTION

*Before turning on the power, turn down the volume of other equipment connected to this unit. Failure to do so might cause sudden loud sounds, which could harm your hearing or result in other trouble.*

#### 28 AC IN connector

Connect the included power cord here.

#### 29 REMOTE (PARALLEL)

This D-sub 37-pin I/O connector is for parallel control.

Use it for external control, including fader starting. (See "Using the parallel connector" on page 35.)

#### 30 REMOTE (SERIAL)

This D-Sub 15-pin I/O connector is for serial control.

Connect a TASCAM RC-9010/RC-9010S remote control (sold separately) here.

## 2 – Names and Functions of Parts

### Home Screen

The following information is shown on the display of the unit.

Home Screen with audio CD

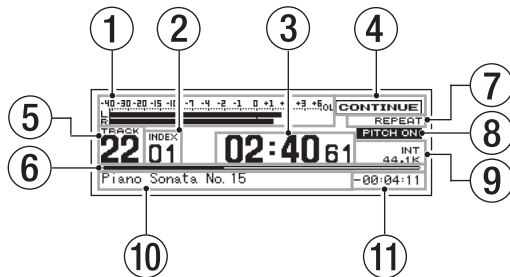

Home Screen with data CD

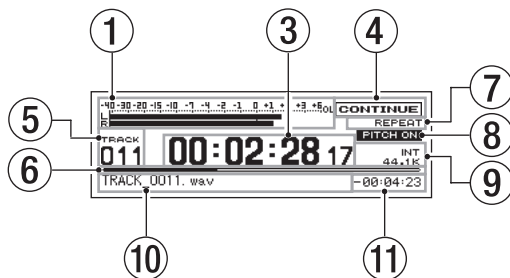

- ① **Playback level meters**  
These show the playback level.  
Depending to the SYSTEM menu MON MIX item setting, only one level bar will be shown and the indicator on the left end will change from LR to 3M, 6M, L, or R. (See "Mono mix setting" on page 30.)  
Even when set to ST, if a mono WAV file is played back, the display will change to M and a single level bar will be shown.  
If you switch the SYSTEM menu METER TYPE item to VU from PEAK, the display will change to a VU-type meter display. (See "Setting the level meter display type" on page 31.)
- ② **Index**  
This shows the currently playing or selected index number (audio CD only).
- ③ **Track time display (main area)**  
This shows the time of the current track.  
The contents depend on the playback media.

Media	Contents shown
Audio CD	Minutes, seconds, frames
Data CD	Hours, minutes, seconds, frames

Pressing the **TIME DISPLAY** button switches between elapsed time display and remaining time display.  
A "-" appears before the remaining time when shown.  
When an EOM tally signal is being output, the ":" blinks. (See "EOM functions" on page 22)

- ④ **Playback mode**  
Shows the current playback mode.

Indicator	Meaning
CONTINUE	Continuous playback mode
SINGLE	Single playback mode
PROGRAM	Program playback mode

- ⑤ **Track number**  
Shows the current track number.
- ⑥ **Track playback position**  
Shows the current playback position as a bar. As playback proceeds, the bar extends from the left.
- ⑦ **Repeat playback function indicator**  
This shows the ON/OFF status of the repeat playback function.

Indicator	Meaning
No indicator	Repeat playback function is OFF
REPEAT	Repeat playback function is ON
REPEAT A-	A-B repeat playback function starting point set
REPEAT A-B	A-B repeat playback function is ON

#### NOTE

The A-B repeat playback function will only be displayed if selected using a TASCAM RC-9010/RC-9010S remote controller (sold separately).

- ⑧ **PITCH indicator**  
The PITCH ON indicator appears if the pitch control function is on.
- ⑨ **Master clock indicator**  
This shows the current master clock.

Indicator	Meaning
INT	Unit's internal clock in use
EXT	Synchronized with the word clock input through the <b>WORD SYNC IN</b> connector
EXT NO CLK	No signal input through the <b>WORD SYNC IN</b> connector
EXT UNLOCK	<b>WORD SYNC IN</b> connector input signal unlocked
EXT (blinking)	Synchronization with word clock input through the <b>WORD SYNC IN</b> connector possible (after playback completes, the unit will automatically resynchronize with the word clock)
44.1K	Master clock frequency is 44.1 kHz
48K	Master clock frequency is 48 kHz

- ⑩ **Information area**  
CD-TEXT will be shown if available.  
File names will be shown when using data CDs.  
When the playback mode is set to PROGRAM, information for the next program item is shown.
- ⑪ **Track time display (sub area)**  
The time of the current track is shown. When the main display area shows the elapsed time, this shows the remaining time, and vice versa.  
A "-" appears before the remaining time when shown.

## 2 – Names and Functions of Parts

### Menu structure

Press the **MENU** button to show the MENU screen.

MENU	
1 PLAY	1 AUTO CUE
2 PROGRAM/CUE	2 AUTO CUE LEVEL
3 REMOTE	3 AUTO READY
4	4 INCREMENTAL PLAY
5 SYSTEM	5 ONLINE BACK CUE
6 INFORMATION	6 PLAY KEY FUNCTION

The menu has five submenus.

1 PLAY	Settings related to playback
2 PROGRAM/CUE	Settings related to program playback and cue point
3 REMOTE	Settings related external remote settings
4	This menu item has been intentionally left blank.
5 SYSTEM	Settings related to the unit's system.
6 INFORMATION	Settings related to media information and the system version, and operating time confirmation.

The submenu items are as follows.

Main menu item	Submenu item	Function/Setting	Reference
1 PLAY	1 AUTO CUE	Auto Cue	P. 19
	2 AUTO CUE LEVEL	Auto Cue level	P. 19
	3 AUTO READY	Auto Ready	P. 20
	4 INCREMENTAL PLAY	Incremental playback	P. 20
	5 ONLINE BACK CUE	Online back cue function	P. 20
	6 PLAY KEY FUNCTION	Function of PLAY and MONITOR buttons when online OFF	P. 20
	7 MONITOR PLAY STBY	STANDBY button function during monitoring playback	P. 21
	8 ONLINE PLAY STBY	STANDBY button function during online playback	P. 21
	9 REPEAT	Repeat playback function	P. 21
	10 EOM	EOM function	P. 22
	11 END CHECK	END CHECK function	P. 22
	12 PITCH	Pitch control function	P. 23
	13 PITCH %	Pitch control value	P. 23
	14 PITCH/TIME FIT	Time and pitch control playback	P. 23
2 PROGRAM/CUE	1 PROGRAM EDIT	Edit programs	P. 24
	4 CUE LIST EDIT	Edit cue lists	P. 26
	7 CUE POINT LOAD	Cue point loading	P. 27
3 REMOTE	1 FADER MODE	Fader function for TASCAM RC-9010/RC-9010S or other external remote (sold separately)	P. 33
	2 FADER START MODE	Fader start function for TASCAM RC-9010/RC-9010S or other external remote (sold separately)	P. 33
	3 FADER STOP MODE	Fader stop function for TASCAM RC-9010/RC-9010S or other external remote (sold separately)	P. 33
	4 FADER STOP ACT	Fader stop function action	P. 34
	5 FADER SCALE	Fader scale switching	P. 34
	6 OPERATION PANEL	Panel lock function	P. 16
	7 P.PORT P3/13 ASGN	Parallel remote connector 3-pin and 13-pin functions	P. 35
	8 SERIAL BAUD RATE	Serial remote connector transmission speed (baud rate)	P. 34

## 2 – Names and Functions of Parts

Main menu item	Submenu item	Function/Setting	Reference	
5	SYSTEM	1 DIGITAL REF LVL	Digital reference level	P. 29
		2 ANALOG REF LVL	Analog output reference level	P. 29
		3 ANALOG REF ADJ L	Adjust the analog output reference level of the L channel	P. 29
		4 ANALOG REF ADJ R	Adjust the analog output reference level of the R channel	P. 29
		5 ONLINE FUNCTION	Online function	P. 29
		6 CLOCK MASTER	Master clock	P. 30
		7 MONO MIX	Mono playback	P. 30
		8 METER TYPE	Meter display	P. 31
		9 FAIL SAFE	Fail-safe function	P. 31
		10 MONITORING POINT	Set monitoring output to before or after the online fader	P. 31
		11 MON MUTE ONLINE	Set automatically mute monitoring during online playback	P. 31
		12 LCD BRIGHTNESS	Display brightness	P. 15
		13 LCD CONTRAST	Display contrast	P. 14
		14 LED BRIGHTNESS	Indicator brightness	P. 15
6	INFORMATION	19 FACTORY PRESET	Restore factory settings	P. 32
		20 DIGITAL OUTPUT TYPE	Set the C-bit of the digital output signal	P. 32
		1 MEDIA INFO	Show information about the media in the CD	P. 32
		2 SYSTEM INFO	Check the system version and operating time	P. 32

### Menu operation basics

You can perform the following operations using the MENU screen.

#### To select an item (vertically on the screen)

- Turn the **DATA** dial.

The selected menu item appears as light letters on a dark background (highlighted in inverse).

#### To confirm the selected item

- Press the **DATA** dial.

#### To go back one menu level

- Press the **MENU** button.

#### To return directly to the Home screen from the Menu screen

- Press the **HOME** button.

#### NOTE

If there are items above or below the currently displayed items in the list, ▲ and/or ▼ will be shown at the top and/or bottom of the list.

### Menu operation procedures

This example explains how to set the auto ready function.

1. Press the **MENU** button to open the MENU screen.

MENU	
1	PLAY
2	PROGRAM/CUE
3	REMOTE
4	
5	SYSTEM
6	INFORMATION

2. Turn the **DATA** dial to select **PLAY**, and press the **DATA** dial to open the **PLAY** menu.

MENU	
1	AUTO CUE OFF
2	AUTO CUE LEVEL -24 dB
3	AUTO READY OFF
4	INCREMENTAL PLAY OFF
5	ONLINE BACK CUE OFF
6	PLAY KEY FUNCTION NORMAL

3. Turn the **DATA** dial to select **AUTO READY**, and press the **DATA** dial to highlight the setting value.

MENU	
1	AUTO CUE OFF
2	AUTO CUE LEVEL -24 dB
3	AUTO READY ON
4	INCREMENTAL PLAY OFF
5	ONLINE BACK CUE OFF
6	PLAY KEY FUNCTION NORMAL

4. Turn the **DATA** dial to set the **AUTO READY** item **ON** or **OFF**.

MENU	
1	AUTO CUE OFF
2	AUTO CUE LEVEL -24 dB
3	AUTO READY ON
4	INCREMENTAL PLAY OFF
5	ONLINE BACK CUE OFF
6	PLAY KEY FUNCTION NORMAL

5. Press the **DATA** dial to return to the **PLAY** menu screen.
6. Repeat steps 3–5 as necessary to set other items.
  - To change a menu item or a setting item, press the **MENU** button to show submenu items and return to step 1.
  - To change the selected setting item, turn the **DATA** dial.
7. Press the **HOME** button to return to the Home screen.

# 3 – Preparations

## Turning the power ON and OFF

Press the **POWER** switch on the rear panel to turn the power ON.

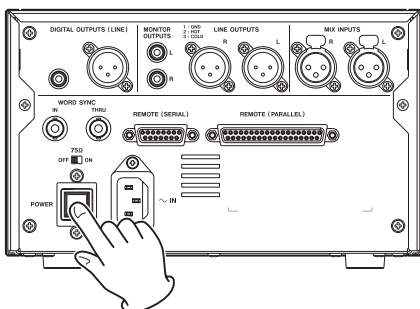

Startup screen



Home Screen

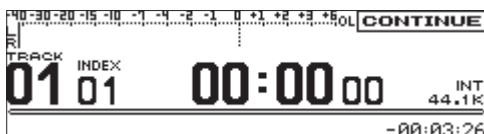

The unit starts and the startup screen appears.

If no CD has been loaded, the screen shows **NO MEDIA**.

If a CD has been loaded, the screen shows **MEDIA READING** while the unit reads the CD. When this process is complete, the Home Screen is displayed.

## Turning the power OFF

Press the **POWER** switch to turn the power OFF. No special shutdown procedures are necessary.

## Adjusting the display

You can adjust the display contrast and brightness as necessary.

### Adjusting display contrast

When the Home Screen is open, use the **TIME DISPLAY** button and **DATA** dial to adjust the display contrast.

You can also use **SYSTEM** menu's **LCD CONTRAST** to adjust it.

#### NOTE

- This operation only adjusts the contrast of this unit. It does not adjust the contrast of a connected TASCAM RC-9010/RC-9010S remote control (sold separately).
- The display contrast setting is retained even when the power is OFF.

### Setting using the controls

With the Home Screen open, while pressing and holding the **TIME DISPLAY** button, turn the **DATA** dial to adjust the unit's display contrast.

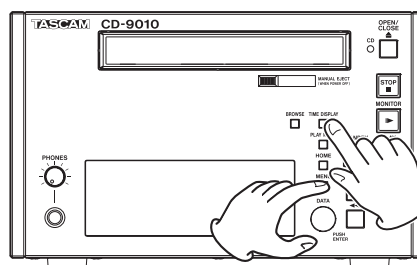

### Setting using the menu

1. Press the **MENU** button to open the **MENU** screen.
2. Open the **SYSTEM** menu.
3. Select **LCD CONTRAST**.

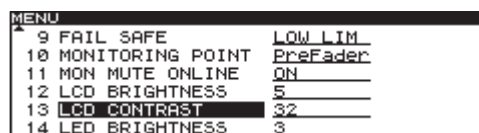

4. Press the **DATA** dial to move the cursor (selected area) right to select the value.
5. Turn the **DATA** dial to adjust the contrast.
  - Options: 0–63 (default value: 32)
6. Press the **HOME** button to return to the Home Screen.

## Adjusting display and indicator brightness

When the Home Screen is open, use the **HOME** button and **DATA** dial to adjust the brightness of the display backlight and the indicators.

You can also use the **SYSTEM** menu screen LCD BRIGHTNESS and LED BRIGHTNESS items to adjust them.

### NOTE

- These operations only adjust the brightness and contrast of the display and indicators of this unit. They do not adjust the brightness and contrast of a connected TASCAM RC-9010/RC-9010S remote control (sold separately).
- The display and indicator BRIGHTNESS settings are retained even when the power is turned OFF.

### Setting using the controls

When the Home Screen is open, while pressing and holding the **HOME** button, turn the **DATA** dial to adjust the brightness of the unit's display and indicators.

You can also adjust the brightness of the display alone by pressing and turning the **DATA** dial while pressing and holding the **HOME** button.

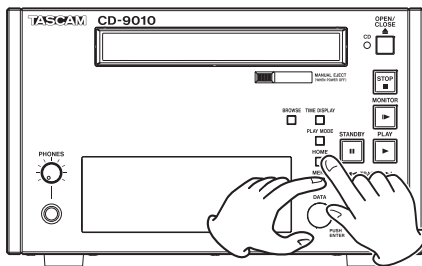

### Setting using the menu

1. Press the **MENU** button to open the MENU screen.
2. Open the **SYSTEM** menu.
3. Select **LCD BRIGHTNESS** or **LED BRIGHTNESS**.

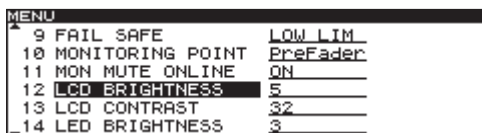

4. Press the **DATA** dial to move the cursor (selected area) right to select the value.

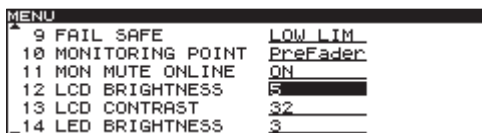

5. Turn the **DATA** dial to adjust the brightness.
  - LCD options: 0-7 (default value: 5)
  - LED options: 0-7 (default value: 3)
6. Press the **HOME** button to return to the Home Screen.

## Connecting headphones

Connect stereo headphones to the **PHONES** jack on the front panel. Use the **PHONES** knob to adjust the headphones output level.

### CAUTION

Before connecting headphones, use the **PHONES** knob to lower the volume. Failure to do so might result in sudden loud sounds, which could harm your hearing or result in other trouble.

### NOTE

The **PHONES** knob can be pushed in to prevent the level from being accidentally changed. The knob can be used when out.

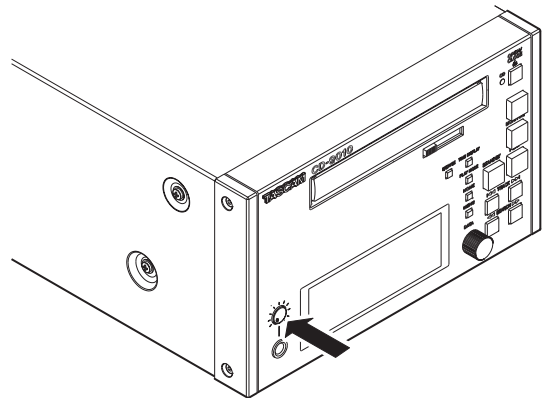

The **PHONES** knob when pushed in

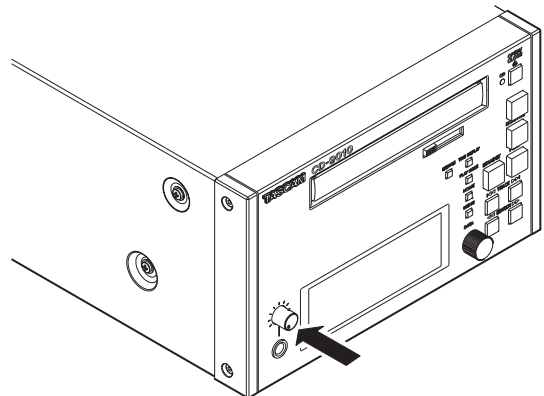

The **PHONES** knob when out

## 3 – Preparations

### Setting the panel lock function

The unit can be set so that it can only be operated using a TASCAM RC-9010/RC-9010S remote control (sold separately).

1. Press the **MENU** button to open the **MENU** screen.
2. Open the **REMOTE** menu screen.
3. Select **OPERATION PANEL**.

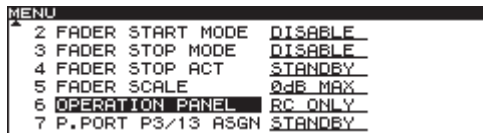

4. Press the **DATA** dial to move the cursor (selected area) right to select the setting.
5. Turn the **DATA** dial to set whether or not you can use the front panel controls to control the unit.
  - **CD+RC**: The unit can be controlled using a TASCAM RC-9010/RC-9010S remote control (sold separately) and the unit's front panel buttons.
  - **RC ONLY** (default value): When a TASCAM RC-9010/RC-9010S remote control (sold separately) is connected, the unit's front panel buttons (other than the **OPEN/CLOSE** button) are disabled.
6. After completing the setting, press the **HOME** button to return to the Home Screen.

#### NOTE

- When a remote is not connected, even when this item is set to **RC ONLY**, the panel controls will not lock.
- To unlock the panel, press the **MENU** button, while pressing and holding the **HOME** button. When the "OPERATION PANEL Change to CD+RC?" pop-up message appears, select "Yes" to unlock the panel.
- You can also lock the panel controls by pressing the **MENU** button while pressing and holding the **HOME** button. When the pop-up message appears, select "Yes".
- The panel lock function setting is stored even when the power is turned **OFF**.



## Monitoring and online playback

This unit has two playback modes: monitoring playback and online playback. The outputs for the two playback modes can be set to be independent of each other.

For example, you can use the monitoring playback mode for broadcast use and on location to cue tracks and playback points in advance to prepare for online playback from those points.

### Monitoring playback

The SYSTEM menu ONLINE FUNCTION item must be set to SWITCH. OK to enable monitoring playback. (See "Setting the online function" on page 29.)

#### NOTE

- If set as above, pushing the PLAY button will output the playback signal to the monitoring destination.
- If set as above, the playback signal will be output to the monitoring destination when jogging and searching.

#### Starting monitoring playback

When stopped, in playback standby or during jog playback, press the MONITOR button.

#### Status of outputs

Output	Status
DIGITAL OUTPUT	Off
LINE OUTPUTS	Off
MONITOR OUTPUTS	On

### Online playback

The SYSTEM menu screen ONLINE FUNCTION item must be set to AlwaysON to enable online playback. (See "Setting the online function" on page 29.)

#### Starting online playback

When in playback standby, monitoring playback or during jog playback, press the PLAY button.

#### Status of outputs

Output	Status
DIGITAL OUTPUT	On
LINE OUTPUTS	On
MONITOR OUTPUTS	Off

#### NOTE

Set the SYSTEM menu MON MUTE ONLINE item to OFF to always send the signal through the MONITOR OUTPUTS. (See "Muting monitoring when online" on page 31.)

## Setting the playback mode

Tracks on the CD can be played using one of the following three playback modes.

#### Continuous playback mode (default setting)

- The CONTINUE indicator appears in the playback mode area of the Home Screen.
- The tracks on the CD are played in track number order.

#### Single playback mode

- The SINGLE indicator appears in the playback mode area of the Home Screen.
- Only the currently selected track is played before playback stops.

#### Program playback mode

- The PROGRAM indicator appears in the playback mode area of the Home Screen.
- Tracks will be played in the order programmed in advance. (See "Program playback" on page 24.)

The current playback mode appears in the playback mode area of the Home Screen.

Use the PLAY MODE button to set the playback mode.

Press this button to cycle through the playback modes in the following order.

→ CONTINUE mode → SINGLE mode → PROGRAM mode →

#### NOTE

- In this manual, unless otherwise specified, explanations assume that the playback mode is set to CONTINUE (continuous playback mode).
- The playback mode setting is retained even when the power is turned OFF.

## 4 – Playback

### Playing a track once from the beginning

Follow these steps to select and check the desired track (monitoring playback), and then play it through the main outputs (online playback). These procedures assume that all menu items are at their default settings.

1. Press the **PLAY MODE** button to select single mode.
  - Press the **PLAY MODE** button as many times as necessary until the **SINGLE** playback mode indicator appears on the Home Screen.
2. Press the **MENU** button to open the **MENU** screen, and set **AUTO CUE** in the **PLAY** menu to **ON**.
3. Press the **HOME** button to open the Home Screen.
4. Use the **TRACK** |◀◀/▶▶| buttons to select a track for playback.
  - The unit enters playback standby at the position where an audio signal is detected in the selected track (and the **STANDBY** button lights).

#### NOTE

When the playback mode is set to **CONTINUE** or **SINGLE**, you can use the number buttons (0 through 9) to select tracks. Enter two digits for audio CDs or three digits for data CDs. (For example, press the 0 button followed by the 2 button to select track 2 on an audio CD.)

5. To check the playback signal, press the **MONITOR** button to start monitoring playback (the **MONITOR** button lights).
  - In addition to using an external monitoring system, you can also monitor the playback signal using headphones connected to the unit's **PHONES** jack.
6. After checking the signal, press the **STANDBY** button.
  - The playback position is set to the point where the track starts and the unit enters playback standby mode (the **STANDBY** button lights).
7. Press the **PLAY** button to start online playback.
  - When the track ends, the unit re-enters playback standby.
  - Press the **STOP** button to stop playback immediately.

### Playing a track from the middle

Follow these steps to find a point in the middle of a track and start playback from the main outputs from that point.

1. When stopped or during playback standby, you can search within a track using the **SEARCH** ◀◀/▶▶ buttons to locate a desired point and put the unit in playback standby there. (See "Searching within tracks" on page 19.)
2. At the desired playback point, press the **MONITOR** button to start monitoring playback and check it.
3. After checking, press the **STANDBY** button to return to the point set earlier and start online playback standby (**STANDBY** button lights).
  - To adjust the set point, return to step 1.
4. Press the **PLAY** button to start online playback.  
When the track ends, the unit will enter playback standby mode.

#### NOTE

Press the **STOP** button to stop playback immediately.

### Automatic cue point memory (last cue)

When you start monitoring playback from a stopped or playback standby state, the starting position is automatically memorized as a cue point.

The most recently added cue point is the "last cue point". Press the **STANDBY** button to locate to the last cue point (where monitoring playback last started) and enter playback standby.

#### NOTE

- When using a **TASCAM RC-9010/RC-9010S** remote control (sold separately), you can assign automatic cue points to the number (0–9) buttons.
- In jog mode, pressing the **STANDBY** button saves the current position as a cue point.

## Setting the playback point

### Selecting tracks

Use the **TRACK** **◀◀/▶▶** buttons to select tracks.

#### ◀◀ button

Press to move to the start of the current track when the elapsed time of the current track is greater than one second. When the elapsed time is less than one second, press this to skip to the beginning of the previous track.

#### ▶▶ button

Press to skip to the beginning of the next track. Press again to skip to the beginning of the track after that.

#### NOTE

- *When in program playback mode, tracks will be skipped in the program order.*
- *When at the beginning of the first track, press the ◀◀ button to skip to the beginning of the last track. When at the beginning of the last track, press the ▶▶ button to skip to the beginning of the first track.*

## Operation after selection of a track

When the **TRACK** **◀◀/▶▶** buttons are used to select a track, what happens next depends on the unit's status and auto cue function setting. (See "Auto cue function" on page 19.)

### When Auto Cue is ON

The unit enters playback standby at the first position within the track where the signal reaches the level set using the **PLAY** menu **AUTO CUE LEVEL** item.

### When Auto Cue is OFF

The unit enters playback standby at the beginning of the track.

## Searching within tracks

When playback is stopped, the unit is in playback standby, or during monitoring or jog playback, press and hold the **SEARCH** **◀◀/▶▶** buttons to search for a cue point.

While pressing one of the **SEARCH** **▶▶** or **◀◀** buttons to search within a track, you can change the search speed by pressing the other **SEARCH** **◀◀/▶▶** button.

## Auto cue function

If the auto cue function is ON, and you select a track for playback, any "silence" at the beginning of the track will be skipped, and the unit will enter playback standby at the first point where the track's "signal" is audible. As a result, sound will be heard immediately when playback starts.

#### NOTE

- *When using the cue function, the Auto Cue function is disabled.*
- *If a track is selected when AUTO CUE is ON, the unit enters playback standby at the first point where the track is audible.*
- *The AUTO CUE function setting is retained even when the power is turned OFF.*

You can specify the threshold level (**AUTO CUE LEVEL**) used to detect the audio signal when the Auto Cue function is activated. In other words, any signal higher than the **AUTO CUE LEVEL** will be treated as "signal," and any signal lower than this level will be treated as "silence."

1. Press the **MENU** button to open the **MENU** screen.
2. Open the **PLAY** menu.
3. Select **AUTO CUE**.

MENU	
1	<b>AUTO CUE</b> OFF
2	<b>AUTO CUE LEVEL</b> -24 dB
3	<b>AUTO READY</b> OFF
4	<b>INCREMENTAL PLAY</b> OFF
5	<b>ONLINE BACK CUE</b> OFF
6	<b>PLAY KEY FUNCTION</b> NORMAL

4. Press the **DATA** dial to move the cursor right to select the setting.
5. Turn the **DATA** dial to set the value to **ON** (default is **OFF**).
6. Press the **DATA** dial to move the cursor to the left, and return to menu item selection.
7. Select **AUTO CUE LEVEL**.

MENU	
1	<b>AUTO CUE</b> OFF
2	<b>AUTO CUE LEVEL</b> -24 dB
3	<b>AUTO READY</b> OFF
4	<b>INCREMENTAL PLAY</b> OFF
5	<b>ONLINE BACK CUE</b> OFF
6	<b>PLAY KEY FUNCTION</b> NORMAL

8. Press the **DATA** dial to move the cursor right to select the setting.
9. Turn the **DATA** dial to set the desired auto cue level.
  - Values: -24 dB to -72 dB (6 dB steps, default -24 dB)
10. After setting the value, press the **HOME** button to return to the Home Screen.

## 4 – Playback

### Auto ready function

If the auto ready function is ON, when a track finishes playing, playback standby will occur at the beginning of the next track.

1. Press the **MENU** button to open the **MENU** screen.
2. Open the **PLAY** menu screen.
3. Select **AUTO READY**.

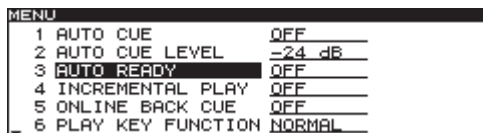

3. Press the **DATA** dial to move the cursor right to select the setting.
4. Turn the **DATA** dial to set the value to **ON** (default is **OFF**).
5. After setting the value, press the **HOME** button to return to the Home Screen.

#### NOTE

- If the auto cue function is set to ON, the unit enters playback standby at the point where sound starts in the next track rather than at the very beginning of the track.
- The auto ready function setting is retained even when the power is turned OFF.

### Incremental playback function

When the incremental playback function is ON, and the unit is playing back, you can use the **PLAY** button to start playback from the beginning of the next track or the **STOP** button to enter playback standby at the beginning of the next track.

1. Press the **MENU** button to open the **MENU** screen.
2. Open the **PLAY** menu screen.
3. Select **INCREMENTAL PLAY**.

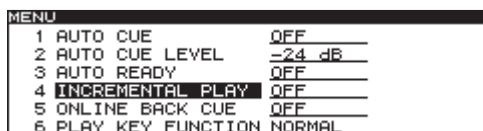

4. Press the **DATA** dial to move the cursor right to select the setting.
5. Turn the **DATA** dial to set the value to **ON** (default is **OFF**).
6. After setting the value, press the **HOME** button to return to the Home Screen.

#### NOTE

- When the incremental playback function is set to ON and the unit is in playback standby mode, pressing the **PLAY** button will start playback from that position. In playback standby, pressing the **STOP** button will stop playback.
- When the last track of the CD is being played, pressing **PLAY** starts playback of the first track on the CD. Pressing **STOP** pauses at the beginning of the first track on the CD.
- The incremental playback function setting is retained even when the power is turned OFF.

### ONLINE BACK CUE function

If this function is on, when the **ON LINE** button is turned OFF on a connected TASCAM RC-9010/RC-9010S remote control (sold separately), the unit immediately enters playback standby at the last cue point (the last point where monitoring playback started).

1. Press the **MENU** button to open the **MENU** screen.
2. Open the **PLAY** menu screen
3. Select **ONLINE BACK CUE**.

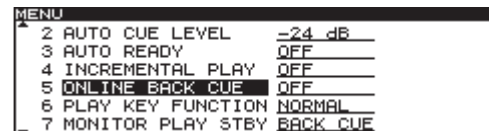

4. Press the **DATA** dial to move the cursor right to select the setting.
5. Turn the **DATA** dial to set the value to **ON** (default is **OFF**).
6. After setting the value, press the **HOME** button to return to the Home Screen.

#### NOTE

The **ONLINE BACK CUE** function setting is retained even when the power is turned OFF.

### PLAY KEY FUNCTION setting

When the **ON LINE** button is turned OFF on a connected TASCAM RC-9010/RC-9010S remote control (sold separately), the **PLAY** button operates as described below.

#### When set to Normal

Pressing the **PLAY** button during playback has no effect. If **INCREMENTAL PLAY** is set to **ON**, however, pressing the **PLAY** button during playback allows incremental playback.

#### When set to Back Cue

If the incremental play function is **OFF**, pressing the **PLAY** button skips to the last cue point and continues playback. Pressing the **PLAY** button in this case activates monitoring playback (monitoring outputs ON, line outputs OFF).

1. Press the **MENU** button to open the **MENU** screen.
2. Open the **PLAY** menu screen.
3. Select **PLAY KEY FUNCTION**.

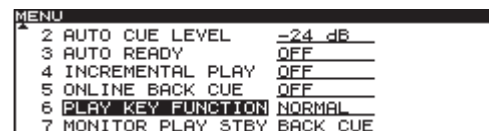

4. Press the **DATA** dial to move the cursor right to select the setting.
5. Turn the **DATA** dial to set the function when online playback mode is **OFF** (default is **OFF**).  
Values are **NORMAL** (default value) and **BACK CUE**.
6. After setting the value, press the **HOME** button to return to the Home Screen.

#### NOTES

- Similar operation is possible using the **MONITOR** button.
- The **PLAY KEY FUNCTION** setting is retained even when the power is turned OFF.

## MONITOR PLAY STBY function

You can set how the **STANDBY** button functions during monitoring playback.

1. Press the **MENU** button to open the **MENU** screen.
2. Open the **PLAY** menu screen
3. Select **MONITOR PLAY STBY**.

MENU	
4	INCREMENTAL PLAY OFF
5	ONLINE BACK CUE OFF
6	PLAY KEY FUNCTION NORMAL
7	<b>MONITOR PLAY STBY BACK_CUE</b>
8	ONLINE PLAY STBY NORMAL
9	REPEAT OFF

4. Press the **DATA** dial to move the cursor right to select the setting.
5. Turn the **DATA** dial to set the **STANDBY** button function during monitoring playback.
  - **NORMAL**: Start playback standby at that point
  - **BACK CUE** (default value): Pause and enter playback standby mode at the last cue point
6. After setting the value, press the **HOME** button to return to the Home Screen.

### NOTE

The **MONITOR PLAY STBY** setting is retained even when the power is turned OFF.

## ONLINE PLAY STBY function

You can set how the **STANDBY** button functions during online playback.

1. Press the **MENU** button to open the **MENU** screen.
2. Open the **PLAY** menu screen
3. Select **ONLINE PLAY STBY**.

MENU	
5	ONLINE BACK CUE OFF
6	PLAY KEY FUNCTION NORMAL
7	MONITOR PLAY STBY BACK_CUE
8	<b>ONLINE PLAY STBY NORMAL</b>
9	REPEAT OFF
10	EOM OFF

4. Press the **DATA** dial to move the cursor right to select the setting.
5. Turn the **DATA** dial to set the function of the **STANDBY** button during online playback
  - **NORMAL** (default value): If the playback mode is **CONTINUE** or **SINGLE**, start playback standby at that point. If the playback mode is **PROGRAM**, start playback standby at the beginning of the next track.
  - **BACK CUE**: Pause and start playback standby at the last cue point.
6. After setting the value, press the **HOME** button to return to the Home Screen.

### NOTE

The **ONLINE PLAY STBY** setting is retained even when the power is turned OFF.

## Repeat playback

You can repeatedly play back all tracks on the CD.

### Ordinary repeat playback

When the repeat playback function is ON, depending on the current playback mode, the following will occur:

- **CONTINUE**: the entire disc is played back repeatedly
- **SINGLE**: the current track is played back repeatedly
- **PROGRAM**: the entire program is played back repeatedly

1. Press the **MENU** button to open the **MENU** screen.
2. Open the **PLAY** menu screen.
3. Select **REPEAT**.

MENU	
7	MONITOR PLAY STBY BACK_CUE
8	ONLINE PLAY STBY NORMAL
9	<b>REPEAT OFF</b>
10	EOM OFF
11	END CHECK 5s
12	PITCH OFF

4. Press the **DATA** dial to move the cursor right to select the setting.
5. Turn the **DATA** dial to set the value to **ON** (default is OFF).
6. After completing the setting, press the **HOME** button to return to the Home Screen.

### To turn repeat playback OFF

- Set the **PLAY** menu **REPEAT** item to OFF.

### NOTE

The **repeat playback** setting is retained even when the power is turned OFF.

# 4 – Playback

## EOM functions

You can set the unit to output EOM tally signals from the **CONTROL I/O PARALLEL** connector when the remaining time on the track is less than the time set here using the EOM function.

### Setting EOM tally output trigger

Set the track remaining time that triggers output of an EOM tally signal.

1. Press the **MENU** button to open the **MENU** screen.
2. Open the **PLAY** menu screen.
3. Select **EOM**.

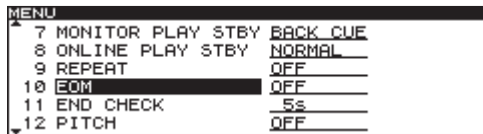

4. Press the **DATA** dial to move the cursor right to select the setting.
5. Turn the **DATA** dial to set the track remaining time to trigger the EOM tally.
  - Options: **OFF** (default value), **0s**, **5s–35s** (in 5-second increments)

#### NOTE

If **EOM TRACK** is set to **0s**, when the track ends, a pulse of about 100 ms will be output.

5. After completing the setting, press the **HOME** button to return to the Home Screen.

#### NOTE

The **EOM** function setting is retained even when the power is turned **OFF**.

## How to use the EOM

1. Connect the device that will receive the EOM tally signal to the **REMOTE (PARALLEL)** connector.
2. Turn **ON** the power of this unit and the receiving device.
3. Begin playback from this unit.
  - When the remaining time of the current track falls below the specified time, an EOM tally signal is output from the **REMOTE (PARALLEL)** connector.

While the EOM tally signal is being output, the ":" in the Home Screen track time display (main display area) blinks.

## Checking the ends of tracks

To check how tracks end, turn the **END CHECK** function **ON**.

### Setting the amount of time checked

Set the time before the end of the track when checking starts.

1. Press the **MENU** button to open the **MENU** screen.
2. Open the **PLAY** menu screen.
3. Select **END CHECK**.

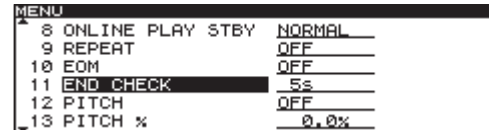

4. Press the **DATA** dial to move the cursor right to select the setting.
5. Turn the **DATA** dial to set the time before the end of the track that checking starts.
  - Options: **5** (default value) –**35** (in 5 second increments)
6. After completing the setting, press the **HOME** button to return to the Home Screen.

#### NOTE

The **END CHECK** function setting is retained even when the power is turned **OFF**.

## How to use the end check function

When using a TASCAM RC-9010/RC-9010S remote control (sold separately), press the **TRACK/[END CHK]** button while pressing and holding the **SHIFT** button to locate to a point at the set number of seconds before the end of the currently selected track and start monitoring playback.

After playback of the last part of the track completes, the unit enters playback standby mode at the last cue point.

## Pitch control playback

You can modify the pitch and speed of the playback, following the procedures here.

### Turning pitch control playback ON/OFF

1. Press the **MENU** button to open the **MENU** screen.
2. Open the **PLAY** menu screen.
3. Select **PITCH**.

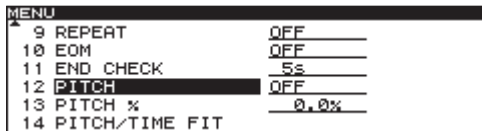

4. Press the **DATA** dial to move the cursor right to select the setting.
5. Turn the **DATA** dial to set pitch control **ON** or **OFF** (default is **OFF**).
6. After completing the setting, press the **HOME** button to return to the Home Screen.

#### NOTE

When you turn pitch control playback **ON** or **OFF** during playback, the playback sound may be momentarily interrupted.

### Setting the pitch control value

1. Press the **MENU** button to open the **MENU** screen.
2. Open the **PLAY** menu screen.
3. Select **PITCH %**.

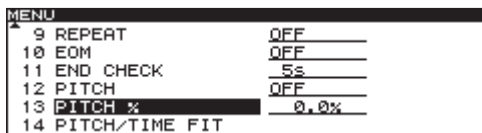

4. Press the **DATA** dial to move the cursor right to select the setting.
5. Turn the **DATA** dial to set the pitch control value.
  - You can set the pitch control to  $\pm 12.5\%$  of normal.
6. After completing the setting, press the **HOME** button to return to the Home Screen.

#### NOTE

- Even when the pitch control function is turned **OFF**, the pitch control value set above is stored and will be used when the pitch control function is turned **ON** again.
- The pitch step setting is retained even when the power is turned **OFF**.

## PITCH/TIME FIT function

You can adjust the time remaining of the current track to a defined value and play it back.

The possible setting range corresponds to a pitch control value range of  $\pm 12.5\%$ .

This setting can be made when stopped or in playback standby.

1. Press the **MENU** button to open the **MENU** screen.
2. Open the **PLAY** menu screen.
3. Select **PITCH/TIME FIT**.

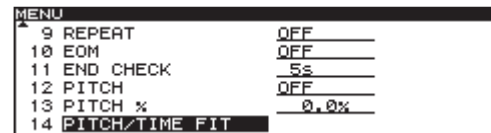

4. Press the **DATA** dial to open the **PITCH/TIME FIT** screen.

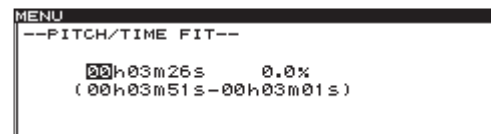

5. Set the playback time as follows:
  - The current track remaining time is shown initially.
  - Turn the **DATA** dial to change the selected item.
  - Press the **DATA** dial to select the playback time units in hours, minutes and seconds order. The permissible range (maximum and minimum) is shown beneath the input line.
6. After completing the setting, press the **DATA** dial to confirm the setting.
 

The setting is saved and reflected in the pitch control value, and the **PLAY** menu screen re-opens.
7. Press the **HOME** button to return to the Home Screen.

# 5 – Program and cue playback

## Program playback

You can create a program in advance to play up to 99 tracks you want in the desired order.

## Program menu operation

Select PROGRAM EDIT and press the DATA dial to open the PROGRAM screen (program list). Select the desired item, and press the DATA dial to open the PROGRAM MENU pop-up with the following options.

### ADD PROGRAM

Adds the highlighted track to the program.

### DELETE ALL PROGRAM

Removes all tracks from the program.

### DELETE PROGRAM

Removes the selected program track.

### MOVE

Move the selected program track to a different position in the program order.

### CANCEL

Close the PROGRAM MENU without conducting any operation and return to the PROGRAM screen.

## Adding tracks to a program

Follow these procedures to set up a program.

1. With playback stopped, press the PLAY MODE button and set the playback mode to PROGRAM (See "Setting the playback mode" on page 17.)
2. Press the MENU button to open the MENU screen.
3. Open the PROGRAM/CUE menu.

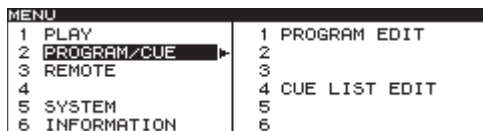

4. Select PROGRAM EDIT.



5. Press the DATA dial to open the PROGRAM screen.



6. Turn the DATA dial to select the number in the program where a track will be added, and press the DATA dial to open the PROGRAM menu.

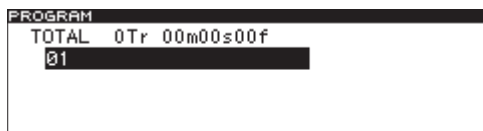

7. Turn the DATA dial to select ADD PROGRAM.

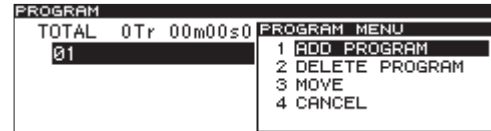

8. Press the DATA dial to open the BROWSE (ADD PROGRAM) screen.

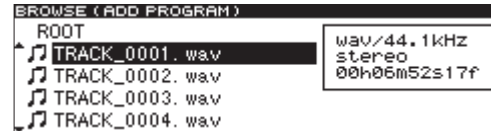

9. Turn the DATA dial to program to select a track, and press the DATA dial to add the track to the program.
10. Repeat steps 6–9 to add more tracks to the program as desired.

The screen shows the number of tracks in the program and the total program time.

## NOTES

- You can add the same track to the program more than once.
- You can add a maximum of 99 tracks to a program. If you try to program a 100th track, a PROGRAM FULL warning message pop-up appears.
- If the total time of the programmed tracks exceeds 99 hours 59 minutes, 59 seconds, "--:--:--" appears on the display.
- A program can only include tracks from one CD. After tracks have been added to a program from one CD, if you try to add a track using a different CD, a "-Cannot Program-" message will appear and the track will not be added.

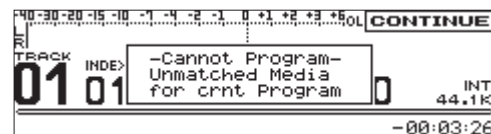

11. When you have finished entering tracks to the program, press the HOME button to return to the Home Screen.
12. Press the MONITOR button or PLAY button to start program playback.

## NOTES

- If you set PROGRAM playback mode but no tracks have been added to the program, the setting will change to CONTINUE when playback starts.
- Program settings are retained even when the power is turned OFF.
- If you try to start program playback when a CD that is different from the one used by the program, a "-Can't Play Program-" message will appear and playback will not start.





## Clearing a program

1. Press the **MENU** button to open the **MENU** screen.
2. Open the **PROGRAM/CUE** menu screen
3. Select **PROGRAM EDIT**.
4. Press the **DATA** dial to open the **PROGRAM** screen.
5. Turn the **DATA** dial to select **TOTAL**.
6. Press the **DATA** dial to open the **PROGRAM** menu.
7. Turn the **DATA** dial to select **DELETE ALL PRGRM**.

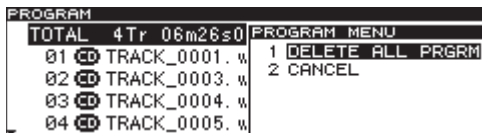

8. Press the **DATA** dial to clear the entire program. When the program has been cleared, the **PROGRAM** screen reopens and **TOTAL 0Tr 00m00s00f** appears.



9. Press the **HOME** button to return to the Home Screen.

## Removing tracks from a program

1. Press the **MENU** button to open the **MENU** screen.
2. Open the **PROGRAM/CUE** menu screen
3. Select **PROGRAM EDIT**.
4. Press the **DATA** dial to open the **PROGRAM** screen.
5. Turn the **DATA** dial to select the track you want to remove.
6. Press the **DATA** dial to open the **PROGRAM** menu.
7. Turn the **DATA** dial to select **DELETE PROGRAM**.

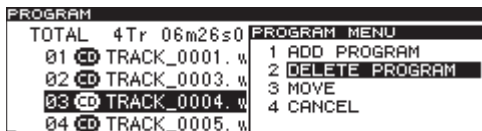

8. Press the **DATA** dial to remove the selected track. After the track is removed, the **PROGRAM** screen reopens.

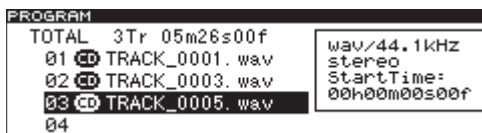

9. Press the **HOME** button to return to the Home Screen.

## Moving tracks within a program

1. Press the **MENU** button to open the **MENU** screen.
2. Open the **PROGRAM/CUE** menu screen
3. Select **PROGRAM EDIT**.
4. Press the **DATA** dial to open the **PROGRAM** screen.
5. Turn the **DATA** dial to select the track to move
6. Press the **DATA** dial to open the **PROGRAM** menu.
7. Turn the **DATA** dial to select **MOVE**.

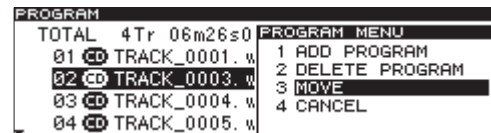

8. Press the **DATA** dial. The track to be moved blinks.

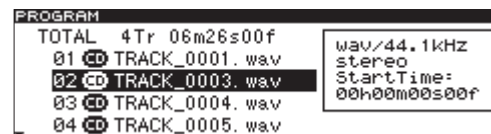

9. Turn the **DATA** dial to move the track to the desired position.

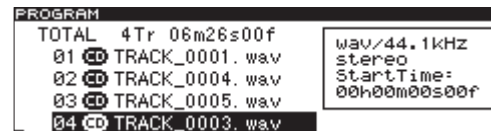

10. Press the **DATA** dial to confirm the new position. When the track move is confirmed, the **PROGRAM** screen reopens.

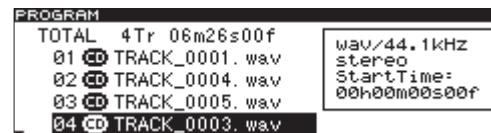

11. Press the **HOME** button to return to the Home Screen.

# 5 – Program and cue playback

## Cue point playback

You can locate to and play back from cue points you have set earlier. You can set up to nine cue points for each CD and save cue points for up to 500 discs.

## Using the cue menu

Select **CUE LIST EDIT** and press the **DATA** dial to open the **CUE** screen (cue list). Select the desired item, and press the **DATA** dial to open the **CUE MENU** pop-up.

### ADD CUE

Add a cue point at the current playback position.

### DELETE ALL CUE

Clear all cue points from the cue list.

### DELETE CUE

Clear the selected cue point.

### EDIT CUE TITLE

Open the **EDIT CUE TITLE** screen where you can edit the name of the selected cue point. (See "Editing cue point names" on page 27.)

### CANCEL

Close the **CUE** menu without performing any operation, and return to the **CUE** screen.

## Adding cue points

Follow these procedures to add cue points.

1. Press the **MENU** button to open the **MENU** screen.
2. Open the **PROGRAM/CUE** menu screen and select **CUE LIST EDIT**.



3. Press the **DATA** dial to open the **CUE** list screen.



4. Turn the **DATA** dial to select the cue point number to add.
5. Press the **DATA** dial to open the **CUE** menu.

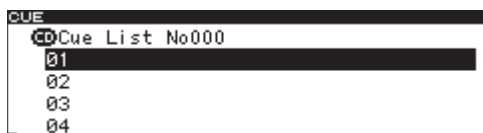

6. Turn the **DATA** dial to select **ADD CUE**.

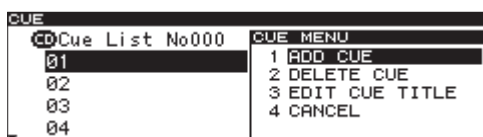

7. Press the **DATA** dial to add the cue point. The current time of the track being played back (or in standby) will be added as a cue point to the cue list.

8. Repeat steps 5–7 to add cue points as desired. The screen shows the track numbers and cue points.
9. When you are done adding cue point, press the **HOME** button to return to the Home Screen.

### NOTE

*CUE settings are retained even when the power is OFF.*

## Clearing the cue list

1. Press the **MENU** button to open the **MENU** screen.
2. Open the **PROGRAM/CUE** menu screen and select **CUE LIST EDIT**.
3. Press the **DATA** dial to open the **CUE** screen.
4. Turn the **DATA** dial to select **Cue List**.
5. Press the **DATA** dial to open the **CUE** menu.
6. Turn the **DATA** dial to select **DELETE ALL CUE**.

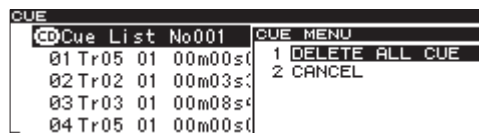

7. Press the **DATA** dial to clear all cue points in the cue list. After the cue points have been cleared, the **CUE** list screen reopens.

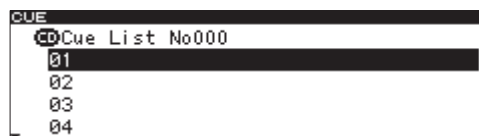

8. Press the **HOME** button to return to the Home Screen.

## Clearing a cue point

1. Press the **MENU** button to open the **MENU** screen.
2. Open the **PROGRAM/CUE** menu screen and select **CUE LIST EDIT**.
3. Press the **DATA** dial to open the **CUE** list screen.
4. Turn the **DATA** dial to select the cue point to be cleared.
5. Press the **DATA** dial to open the **CUE** menu.
6. Turn the **DATA** dial to select **DELETE CUE**.

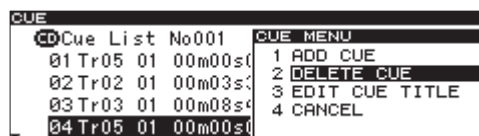

7. Press the **DATA** dial to clear the highlighted cue point. After the cue point has been cleared, the **CUE** list screen reopens.

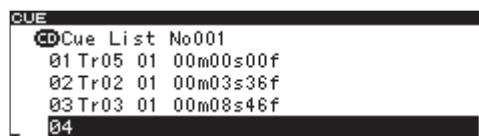

8. Press the **HOME** button to return to the Home Screen.

## Editing cue point names

1. Press the **MENU** button to open the **MENU** screen.
2. Open the **PROGRAM/CUE** menu screen
3. Select **CUE LIST EDIT**.
4. Press the **DATA** dial to open the **CUE** screen.
5. Turn the **DATA** dial to select the cue point with the name to be edited, and press the **DATA** dial to open the **CUE** menu.
6. Turn the **DATA** dial to select **EDIT CUE TITLE**.

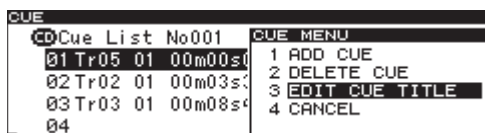

7. Press the **DATA** dial to open the **EDIT CUE TITLE** screen.



8. Edit the cue point name. See "Editing text" below for instructions
9. When you are done editing the name, press the **BROWSE** button to confirm the name change and return to the **CUE** list screen.

### NOTE

- Names containing characters other than the letters of the alphabet, numbers and symbols cannot be edited.
- The following symbols and punctuation marks cannot be used in names.  
¥/;,:\*?"<>|
- Cue point names can be up to six single-byte characters in length.

## Editing text

Edit text using the following operations.

### To move the editing (cursor) position

Use the **SEARCH** ◀/▶ buttons.

### To change the character at the cursor position

Turn the **DATA** dial.

### To confirm the character at the cursor position

Press the **DATA** dial.

### To insert an empty space

Press the **TRACK** ▶▶ button.

### To delete a character

Press the **TRACK** ◀◀ button.

### To confirm and end editing

Press the **BROWSE** button.

## Automatic cue point loading options

Usually when a disc for which cue points have already been saved is loaded, the previous cue points are automatically loaded. Sometimes, though, you might not want to use the memorized cue points.

You can set whether or not memorized cue points are automatically loaded.

1. Press the **MENU** button to open the **MENU** screen.
2. Open the **PROGRAM/CUE** menu screen.
3. Select **CUE POINT LOAD**.

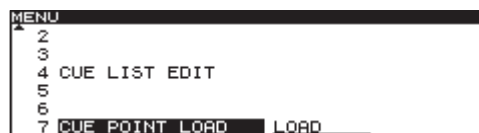

4. Press the **DATA** dial to move the cursor to the right and select the setting.

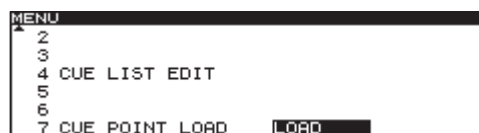

5. Turn the **DATA** dial to change the setting for memorized cue point loading.
  - **LOAD** (default): Automatically load previously memorized cue points
  - **UNLOAD**: Do not load memorized cue points
  - **SELECT**: Every time the power is turned ON, a pop-up menu appears that lets you decide whether or not to load cue points. The setting you select stays active until the power is turned OFF again.

Pop-up that appears when set to **SELECT**



6. Press the **DATA** dial again to set the cue list load setting, and return to the **PROGRAM/CUE** menu screen.
7. Press the **HOME** button to return to the Home Screen.

### NOTE

When set to **UNLOAD** (or when set to **SELECT** and you chose not to load cue points), the unit will function as follows.

- New cue points that are added will not be saved.
- When the active device is changed, all cue points will be cleared.
- When the setting is changed from **UNLOAD** to **LOAD** (and vice versa), the change will become effective the next time the unit is turned ON again. (The cue list will not be loaded immediately when set to **LOAD**.)
- When set to **UNLOAD**, exporting the cue points will not export the recently added ones. (It will export the points added when last set to **LOAD**.)

# 6 – Working with files and folders

Using the **BROWSE** screen, you can work with WAV files on a data CD in a folder structure. You can select folders and files, and then enter folders and work with files.

## NOTE

You cannot use this screen with unfinalized data CDs containing WAV files.

## Opening the BROWSE screen

The following operations assume that a data CD containing WAV files is loaded.

When stopped, in playback standby or playing back, press the **BROWSE** button to open the **BROWSE** screen.



When in playback standby, the **BROWSE** screen for the folder containing the currently selected file opens and that file is highlighted.

## Navigating the BROWSE screen

When the **BROWSE** screen is open, use the **DATA** dial to select folders and files.

- Press the **DATA** dial to open the **BROWSE MENU** pop-up for that file or folder. (See “Folder operations” on page 28.)
- When the **BROWSE** menu is open, press the **BROWSE** button to close the **BROWSE** menu.
- When a folder or file is selected, press the **BROWSE** button to scroll through folder and file names.
- When the **BROWSE** screen is open, press the **HOME** button to return to the Home Screen.
- When a file or folder is selected, press the **PLAY** button to return to the Home Screen and play that file or folder.
- When a file or folder is selected, press the **STANDBY** button to return to the Home Screen and put that file or folder into playback standby.

## Icons on the BROWSE screen

The icons that appear on the **BROWSE** screen have the following meanings.

### Folder (📁)

Folders are shown with this icon.

### Audio file (🎵)

The names of music files appear next to these icons.

Track titles are shown when CD-TEXT is available.

## Folder operations

Select the desired folder on the **BROWSE** screen, and press the **DATA** dial to open the folder **BROWSE MENU** pop-up.

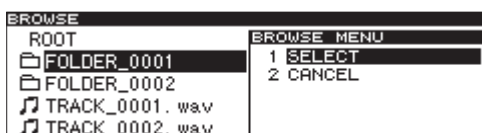

Turn the **DATA** dial to select the desired item, and press the **DATA** dial to execute one of the following operations.

### SELECT

Opens the selected folder.

### CANCEL

Cancels any operation with the selected folder, closes the **BROWSE MENU** and returns to the **BROWSE** screen.

## File and folders on data CDs

Some data CDs store files inside folders in the same way that ordinary computers do. In addition, several folders can be stored inside another folder, creating a multilevel structure.

This unit assigns a folder number to each folder to manage them. Folder numbers are assigned sequentially starting with the folders at the highest level followed by the folders (subfolders) inside them.

If the root folder of a data CD contains one or more audio files, it will be numbered as the first folder.

Each audio file is also assigned a number. File numbers are assigned in order starting from those in the lowest numbered folder.

During ordinary playback of data CDs, tracks are played back in the assigned numerical order just like those on audio CDs.

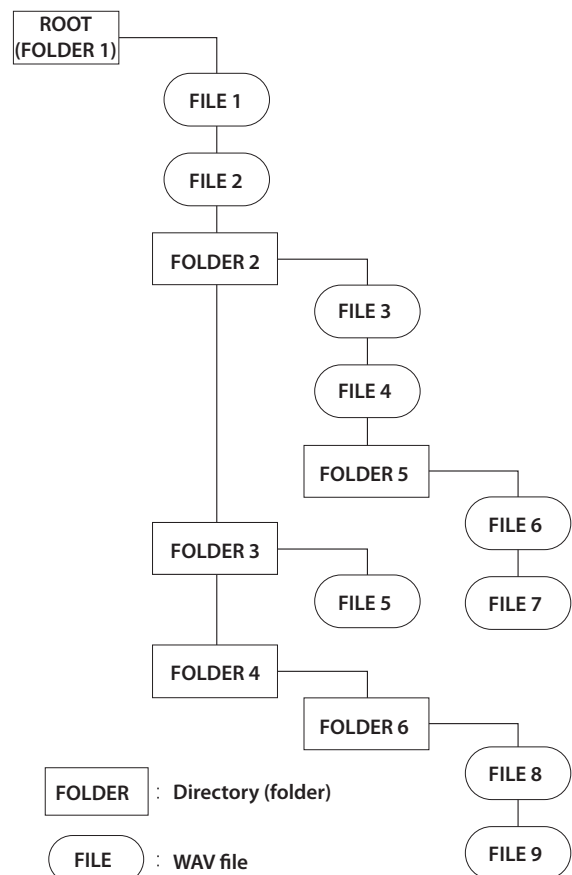

Data CD structure

# 7 – Other settings and information display

## Setting the digital reference level

You can set the digital headroom (number of dB below maximum analog output reference level (full scale)).

1. Press the **MENU** button to open the **MENU** screen.
2. Open the **SYSTEM** menu.
3. Select **DIGITAL REF LVL**.

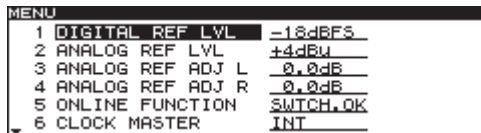

4. Press the **DATA** dial to move the cursor right to select the setting.
5. Turn the **DATA** dial to set the digital reference level.
  - Options: -20dBFS, -18dBFS (default value), -16dBFS, -14dBFS, -9dBFS
6. After completing the setting, press the **HOME** button to return to the Home Screen.

### NOTE

- The digital reference level setting is retained even when the power is turned OFF.
- This setting only applies to the line outputs.

## Setting the analog reference level

You can set the analog output reference level.

The analog audio output reference level settings that are possible depend on the digital reference level setting.

1. Press the **MENU** button to open the **MENU** screen.
2. Open the **SYSTEM** menu.
3. Select **ANALOG REF LVL**.

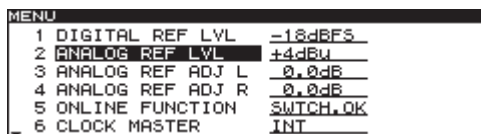

4. Press the **DATA** dial to move the cursor right to select the setting.
5. Turn the **DATA** dial to set the analog reference level. The analog reference setting value options depend on the **DIGITAL REF LVL** setting.

DIGITAL REF LVL setting	ANALOG REF LVL setting
-9dBFS	+6dBu only
Settings other than -9dBFS	-20dBu, +4dBu (default value)

6. After completing the setting, press the **HOME** button to return to the Home Screen.

### NOTE

- This setting only applies to the line outputs.
- This analog reference level setting is retained even when the power is turned OFF.

## Adjusting R/L analog reference levels

You can adjust the analog output reference level separately for the left and right channels.

1. Press the **MENU** button to open the **MENU** screen.
2. Open the **SYSTEM** menu
3. Select **ANALOG REF ADJ L** or **ANALOG REF ADJ R**.

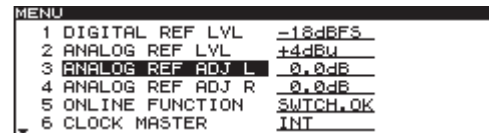

4. Press the **DATA** dial to move the cursor right to select the setting.
5. Turn the **DATA** dial to adjust the analog reference level.
  - Setting range:  $\pm 6.0$  dB (default value: 0dB, 0.1dB increments)
6. After completing the setting, press the **HOME** button to return to the Home Screen.

### NOTE

- The analog reference level settings are retained even when the power is turned OFF.
- This setting only applies to the line outputs.

## Setting the online function

You can set whether or not to use the online function.

1. Press the **MENU** button to open the **MENU** screen.
2. Open the **SYSTEM** menu.
3. Select **ONLINE FUNCTION**.

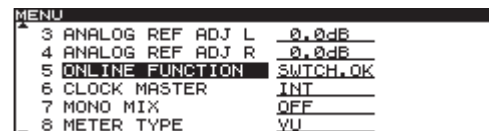

3. Press the **DATA** dial to move the cursor right to select the setting.
4. Turn the **DATA** dial to set the online function.
  - **SWITCH\_OK** (default value): Online playback mode can be controlled through the parallel remote connector, the serial remote connector, and by a TASCAM RC-9010/RC-9010S remote controller (sold separately). When this unit is used alone, online playback mode is ON by default.
  - **Always ON**: Online playback mode is always ON and cannot be switched.
6. After completing the setting, press the **HOME** button to return to the Home Screen.

### NOTE

The online function setting is retained even when the power is turned OFF.

# 7 – Other settings and information display

## Setting the master word clock

You can set the source to use for word synchronization.

1. Press the **MENU** button to open the **MENU** screen.
2. Open the **SYSTEM** menu.
3. Select **CLOCK MASTER**.

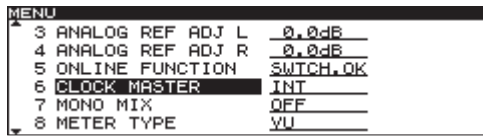

4. Press the **DATA** dial to move the cursor right to select the setting.
5. Turn the **DATA** dial to set the master word clock.
  - **INT** (default value): Use the unit's internal clock
  - **EXT**: Synchronize with the word clock input through the **WORD SYNC IN** connector
  - **44.1K FIX**: Regardless of the file sampling frequency, digital audio is always output at 44.1k FS.
6. After completing the setting, press the **HOME** button to return to the Home Screen.

### NOTE

- The master clock setting is retained even when the power is turned OFF.
- Depending on the combination of master clock and playback file sampling frequency settings, the digital output sampling frequency will differ. (See "Master clock and digital output combinations" below.)

## Mono mix setting

You can set the mono mix output for when the **STEREO/MONO** button is used to set the output to mono. The setting state is shown to the left of the level meters.

1. Press the **MENU** button to open the **MENU** screen.
2. Open the **SYSTEM** menu.
3. Select **MONO MIX**.

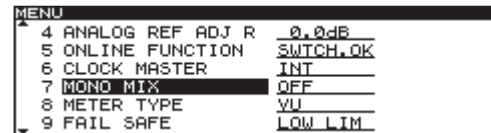

4. Press the **DATA** dial to move the cursor right to select the setting.
5. Turn the **DATA** dial to set the mono mix.

-6dB L+R	The left and right channels of the stereo audio track are each attenuated by -6 dB, summed and then output.
-3dB L+R	The left and right channels of the stereo audio track are each attenuated by -3 dB, summed and then output.
L Mono	The left channel of the stereo audio track is output from both L and R outputs.
R Mono	The right channel of the stereo audio track is output from both L and R outputs.
OFF (default value)	The mono mix function is OFF.

6. After completing the setting, press the **HOME** button to return to the Home Screen.

### NOTE

The mono mix setting is retained even when the power is turned OFF.

## Master clock and digital output combinations

Depending on the combination of the master clock setting and the playback file sampling frequency, the digital output sampling frequency varies. This table shows the combinations.

Master clock	Master clock setting	Playback file sampling frequency	SRC (automatic)	Digital output sampling frequency	Notes
Internal	INT	44.1 kHz	OFF	44.1 kHz	The whole system uses 44.1kHz internal clock
	44.1kHz FIX	44.1 kHz	OFF	44.1 kHz	Digital output is always 44.1 kHz
	44.1kHz FIX	48 kHz	ON	44.1 kHz	Digital output is always 44.1 kHz
	INT	48 kHz	OFF	48 kHz	The whole system uses 48kHz internal clock
External (44.1kHz)	EXT	44.1 kHz	OFF	44.1 kHz	The whole system uses 44.1kHz external clock
External (48kHz)	EXT	44.1 kHz	ON	48 kHz	While syncing to 48kHz external clock, the system uses 44.1kHz internal clock
	EXT	48 kHz	OFF	48 kHz	The whole system uses 48kHz external clock

### NOTE

- The sampling rate converter (SRC) function is turned ON and OFF automatically.
- If the clock is interrupted when synchronized with a 48kHz external clock, the unit will switch to internal clock, the sampling rate converter (SRC) function will turn ON and output will continue at 48 kHz.

# 7 – Other settings and information display

## Fail safe function setting

The fail safe function prevents the accidental operation of buttons. Different buttons are disabled during playback and online playback. See the table below for details

1. Press the **MENU** button to open the **MENU** screen.
2. Open the **SYSTEM** menu.
3. Select **FAIL SAFE**.

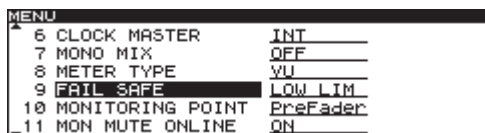

4. Press the **DATA** dial to move the cursor (selected area) right to select the setting.
5. Turn the **DATA** dial to set the fail safe function.  
Options: **LOW LIM** (default value), **UP LIM**, **OFF**
6. After completing the setting, press the **HOME** button to return to the Home Screen.

### NOTE

The fail safe setting is retained even when the power is turned OFF.

Buttons disabled according to fail safe setting

Fail safe setting	Disabled buttons during playback standby	Disabled buttons during online playback	
LOW LIM	None	BROWSE button	
		PLAY MODE button	
		MENU button	
		ENTER button	
		OPEN/CLOSE button	
		TRACK I◀◀/▶▶ buttons	
		SEARCH ◀◀/▶▶ buttons	
UP LIM	BROWSE button	BROWSE button	
	---	PLAY MODE button	
	MENU button	MENU button	
	ENTER button	ENTER button	
	OPEN/CLOSE button	OPEN/CLOSE button	
	---	STANDBY button	
	TRACK I◀◀/▶▶ buttons	TRACK I◀◀/▶▶ buttons	
SEARCH ◀◀/▶▶ buttons	SEARCH ◀◀/▶▶ buttons		
OFF	None	---	MONITOR button
		None	

## Setting the level meter display type

You can change the type of the playback level meters on the Home Screen.

1. Press the **MENU** button to open the **MENU** screen.
2. Open the **SYSTEM** menu.
3. Select **METER TYPE**.

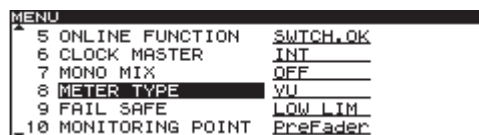

4. Press the **DATA** dial to move the cursor right to select the setting.
5. Turn the **DATA** dial to set the type of level meters shown.
  - **PEAK**: Peak meters shown
  - **VU** (default value): VU meters shown.
6. After completing the setting, press the **HOME** button to return to the Home Screen.

### NOTE

The level meter type setting is retained even when the power is turned OFF.

## Monitoring point setting

You can set whether the monitoring output signal is from before or after the Online fader.

1. Press the **MENU** button to open the **MENU** screen.
2. Open the **SYSTEM** menu.
3. Select **MONITORING POINT**.

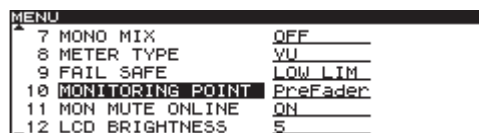

4. Press the **DATA** dial to move the cursor right to select the setting.
5. Turn the **DATA** dial to set the monitoring point.
  - **PreFader** (default value): Monitor the signal before the Online fader
  - **PostFader**: Monitor the signal after the Online fader
6. After completing the setting, press the **HOME** button to return to the Home Screen.

### NOTE

The monitoring point setting is retained even when the power is turned OFF.

## Muting monitoring when online

You can set whether or not monitoring output is automatically muted during online playback.

1. Press the **MENU** button to open the **MENU** screen.
2. Open the **SYSTEM** menu.
3. Select **MON MUTE ONLINE**.

## 7 – Other settings and information display

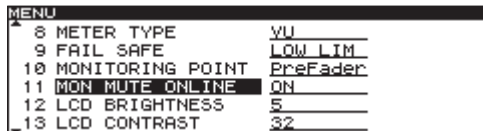

4. Press the **DATA** dial to move the cursor right to select the setting.
5. Turn the **DATA** dial to set whether monitoring output muting during online playback is ON or OFF.
  - Options: OFF, ON (default value)
6. After completing the setting, press the **HOME** button to return to the Home Screen.

### NOTE

The monitor mute online setting is retained even when the power is turned OFF.

## Restoring the factory settings

You can restore all the settings that are stored in the unit's backup memory to the values when shipped from the factory. Follow these steps to restore the settings.

### NOTE

The factory settings cannot be restored if a CD is loaded. Remove the CD and conduct the operation again.

1. Press the **MENU** button to open the **MENU** screen.
2. Open the **SYSTEM** menu.
3. Select **FACTORY PRESET**.

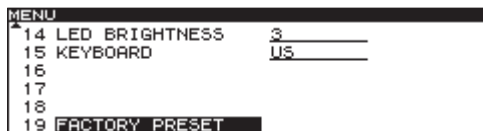

4. Press the **DATA** dial to open a confirmation pop-up message.

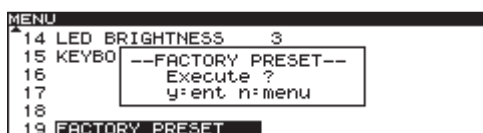

5. Press the **DATA** dial again to restore all settings to their factory defaults. **COMPLETE** appears as a pop-up message when done and the Home Screen automatically reopens.

## Setting the digital output format

You can set the signal format used for digital output. Follow these steps to make the setting.

1. Press the **MENU** button to open the **MENU** screen.
2. Open the **SYSTEM** menu.
3. Select **DIGITAL OUTPUT TYPE**.



4. Press the **DATA** dial to move the cursor right to select the setting.
5. Turn the **DATA** dial to set the digital output format.
  - Options: PRO (default value), CONSUMER

The digital output format setting is retained even when the power is turned OFF.

## Viewing media information

You can view information about the CD. Follow these steps to access this information.

1. Press the **MENU** button to open the **MENU** screen.
2. Open the **INFORMATION** menu screen.
3. Select **MEDIA INFO**.



4. Press the **DATA** dial to show information about the CD, including its used space and amount of free space.

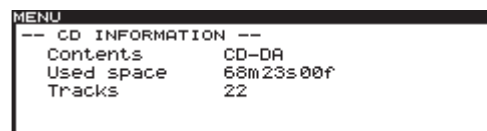

5. When you are finished checking, press the **HOME** button to return to the Home Screen.

## Viewing system information

You can view information about the system. Follow these steps to access this information.

1. Press the **MENU** button to open the **MENU** screen.
2. Open the **INFORMATION** menu screen.
3. Select **SYSTEM INFO**.



4. Press the **DATA** dial to show the **SYSTEM INFORMATION** screen, where you can check system versions and operating time.

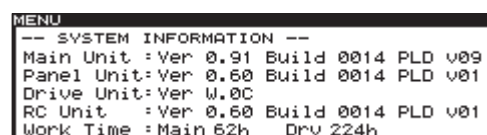

5. When you are finished checking, press the **HOME** button to return to the Home Screen.



# 8 – Using the remote connectors

## Using the serial connector

Using the **REMOTE (SERIAL)** connector (15-pin, D-sub, RS-232C standard), you can control the unit using a TASCAM RC-9010/RC-9010S remote control (sold separately), a computer or other external device.

Use the menu to make communication-related settings.

## Fader use setting

Set whether or not the use of a fader on a TASCAM RC-9010/RC-9010S remote control (sold separately) is enabled.

1. Press the **MENU** button to open the **MENU** screen.
2. Open the **REMOTE** menu screen.
3. Select **FADER MODE**.

MENU		
1	FADER MODE	DISABLE
2	FADER START MODE	DISABLE
3	FADER STOP MODE	DISABLE
4	FADER STOP ACT	STANDBY
5	FADER SCALE	0dB MAX
6	OPERATION PANEL	RC ONLY

4. Press the **DATA** dial to move the cursor right to select the setting.
5. Turn the **DATA** dial to enable or disable fader use.
  - Options: **ENABLE**, **DISABLE** (default value)

### NOTE

When set to **DISABLE**, the internal fader is fixed at 0 dB.

6. After making the setting, press the **HOME** button to return to the Home Screen.

### NOTE

The fader mode setting is retained even when the power is turned OFF.

## Fader start function setting

Fader start allows playback to start by moving the fader of a connected TASCAM RC-9010/RC-9010S remote control (sold separately) from ∞ when the unit is in playback standby.

Enable or disable this function when fader starting is also enabled on the remote.

1. Press the **MENU** button to open the **MENU** screen.
2. Open the **REMOTE** menu screen.
3. Select **FADER START MODE**.

MENU		
1	FADER MODE	DISABLE
2	FADER START MODE	DISABLE
3	FADER STOP MODE	DISABLE
4	FADER STOP ACT	STANDBY
5	FADER SCALE	0dB MAX
6	OPERATION PANEL	RC ONLY

4. Press the **DATA** dial to move the cursor right to select the setting.
5. Turn the **DATA** dial to set enable or disable the fader start function.
  - Options: **ENABLE**, **DISABLE** (default value)
6. After completing the setting, press the **HOME** button to return to the Home Screen.

### NOTE

The fader start mode setting is retained even when the power is turned OFF.

## Fader stop function setting

The fader stop function that allows playback to be stopped or paused (playback standby) by moving the fader of a connected TASCAM RC-9010/RC-9010S remote control (sold separately) to ∞. Set whether or not this function is enabled when fader starting is also enabled on the remote.

### NOTE

If you set both the **FADER START MODE** and **FADER STOP MODE** to **DISABLE**, the fader start function of the TASCAM RC-9010/RC-9010S remote control (sold separately) will be turned OFF automatically, and its **FADER START** button indicator will be unlit. In this state, if you press the **FADER START** button on the remote control, the pop-up message "Can't Change Now, Fixed in crnt mode" appears.

1. Press the **MENU** button to open the **MENU** screen.
2. Open the **REMOTE** menu screen.
3. Select **FADER STOP MODE**.

MENU		
1	FADER MODE	DISABLE
2	FADER START MODE	DISABLE
3	FADER STOP MODE	DISABLE
4	FADER STOP ACT	STANDBY
5	FADER SCALE	0dB MAX
6	OPERATION PANEL	RC ONLY

4. Press the **DATA** dial to move the cursor right to select the setting.
5. Turn the **DATA** dial to enable or disable the fader stop start function.
  - Options: **ENABLE**, **DISABLE** (default value)
6. After completing the setting, press the **HOME** button to return to the Home Screen.

### NOTE

The fader stop mode setting is retained even when the power is turned OFF.

## 8 – Using the remote connectors

### Fader stop action setting

When the fader start function is ON, you can set whether using the fader stop function (lowering the fader to ∞) on a TASCAM RC-9010/RC-9010S remote control (sold separately) causes playback to stop or pause (playback standby).

1. Press the **MENU** button to open the **MENU** screen.
2. Open the **REMOTE** menu screen.
3. Select **FADER STOP ACT.**

MENU	
1 FADER MODE	DISABLE
2 FADER START MODE	DISABLE
3 FADER STOP MODE	DISABLE
4 FADER STOP ACT	STANDBY
5 FADER SCALE	0dB MAX
6 OPERATION PANEL	RC ONLY

4. Press the **DATA** dial to move the cursor right to select the setting.
5. Turn the **DATA** dial to set the action when fader stop occurs.
  - Options: STOP, STANDBY (default value)
6. After completing the setting, press the **HOME** button to return to the Home Screen.

#### NOTE

- Depending on the **PLAY** menu screen **MONITOR PLAY STBY** item and **ONLINE PLAY STBY** settings, **BACK CUE** operation might take place.
- The fader stop act setting is retained even when the power is turned OFF.

### Setting the fader scale used

You can set whether to use the scale shown on the left or right side of the fader on a TASCAM RC-9010/RC-9010S remote control (sold separately). The indicator above the active scale lights.

1. Press the **MENU** button to open the **MENU** screen.
2. Open the **REMOTE** menu screen.
3. Select **FADER SCALE.**

MENU	
2 FADER START MODE	DISABLE
3 FADER STOP MODE	DISABLE
4 FADER STOP ACT	STANDBY
5 FADER SCALE	0dB MAX
6 OPERATION PANEL	RC ONLY
7 P.PORT P3/13 ASGN	STANDBY

4. Press the **DATA** dial to move the cursor right to select the setting.
5. Turn the **DATA** dial to set the fader scale used.
  - Options: 10dB MAX (left scale), 0dB MAX (right scale, default value)
6. After completing the setting, press the **HOME** button to return to the Home Screen.

#### NOTE

The fader scale setting is retained even when the power is turned OFF.

### Transmission speed setting

You can set the transmission speed (baud rate) used with a TASCAM RC-9010/RC-9010S remote control (sold separately) or other remote control using serial protocol.

#### NOTE

The following serial transmission values are fixed: 8 data bits, No parity bit, 1 stop bit.

1. Press the **MENU** button to open the **MENU** screen.
2. Open the **REMOTE** menu screen.
3. Select **SERIAL BAUD RATE.**

MENU	
3 FADER STOP MODE	DISABLE
4 FADER STOP ACT	STANDBY
5 FADER SCALE	0dB MAX
6 OPERATION PANEL	RC ONLY
7 P.PORT P3/13 ASGN	STANDBY
8 SERIAL BAUD RATE	RC

4. Press the **DATA** dial to move the cursor right to select the setting.
5. Turn the **DATA** dial to set the baud rate used to communicate with external remotes.
  - Options: 9600bps, 19200bps, 38400bps, RC (for TASCAM RC-9010/RC-9010S, default value)
6. After completing the setting, press the **HOME** button to return to the Home Screen.

#### NOTE

The serial baud rate setting is retained even when the power is turned OFF.

## 8 – Using the remote connectors

### Using the parallel connector

Using the **REMOTE (PARALLEL)** connector, you can control this unit with an external controller.

The pin assignments are as follows.

Pin	Function	IN/OUT
1	ON LINE PLAY IN	IN
2	MONITOR PLAY IN	IN
3	STANDBY IN/PAUSE (JOG ON) IN**	IN
4	STANDBY IN	IN
5	STOP IN	IN
6	TRACK SEARCH REV IN [I◀◀]	IN
7	N.C	-
8	TRACK SEARCH FWD IN [▶▶I]	IN
9	SEARCH REV IN [◀◀]	IN
10	SEARCH FWD IN [▶▶]	IN
11	MONITOR PLAY TALLY	OUT
12	STANDBY TALLY	OUT
13	STANDBY TALLY/ PAUSE (JOG ON) TALLY**	OUT
14	STOP TALLY	OUT
15	INDEX SEARCH REV IN [←]	IN
16	INDEX SEARCH FWD IN [→]	IN
17	ON LINE PLAY TALLY	OUT
18	CUE UP	IN
19	ON LINE IN	IN
20	EOM OUT	OUT
21	FADER START/STOP IN	IN
22	ON LINE TALLY	OUT
23	TEN KEY 0	IN
24	TEN KEY 1	IN
25	TEN KEY 2	IN
26	TEN KEY 3	IN
27	TEN KEY 4	IN
28	TEN KEY 5	IN
29	TEN KEY 6	IN
30	TEN KEY 7	IN
31	TEN KEY 8	IN
32	TEN KEY 9	IN
33	CD_TALLY	OUT
34	Reserved	-
35	CUE UP_TALLY	OUT
36	GND	-
37	+5V*	-

**IN:** Active low external command reception (operates when at ground 50 ms or longer)

**OUT:** Signal for tally output display by open collector (50V maximum voltage, 100mA maximum current)

\*100mA maximum supplied current

\*\*Use the P.PORT P3/13 ASGN item on the REMOTE menu screen to set their functions. (See "Parallel port 3-pin/13-pin setting" below.)

The following is an example of a connection for playback control of this unit using fader start/stop.

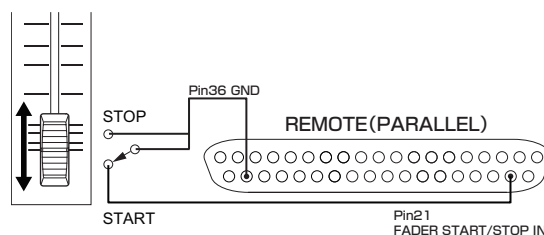

### Parallel port 3-pin/13-pin setting

You can set the functions of the unit's **REMOTE (PARALLEL)** connector 3-pin and 13-pin.

1. Press the **MENU** button to open the MENU screen.
2. Open the **REMOTE** menu screen.
3. Select **P.PORT P3/13 ASGN**.

MENU	
3	FADER STOP MODE <u>DISABLE</u>
4	FADER STOP ACT <u>STANDBY</u>
5	FADER SCALE <u>0.5R MAX</u>
6	OPERATION PANEL <u>RC ONLY</u>
7	<b>P.PORT P3/13 ASGN</b> <u>STANDBY</u>
8	SERIAL BAUD RATE <u>RC</u>

4. Press the **DATA** dial to move the cursor right to select the setting.
5. Turn the **DATA** dial to set the **REMOTE (PARALLEL)** connector 3-pin and 13-pin functions.  
Options: PAUSE, STANDBY (default value)

Pin number	P.PORT P3/13 ASGN setting	
	PAUSE	STANDBY
3	PAUSE (JOG ON) IN	STANDBY IN
13	PAUSE (JOG ON) TALLY	STANDBY TALLY

6. After completing the setting, press the **HOME** button to return to the Home Screen.

#### NOTE

The pin assignment setting is retained even when the power is turned OFF.

# 9 – Message list

## Error messages

If one of the following error messages appears in a pop-up, press the **DATA** dial to close the message. Then try to resolve the issue. If you are still unable to correct the problem, please contact the dealer from which you purchased the unit or a TASCAM service center (see the back cover of this manual).

	1st line	2nd line	Meaning
1	- error -	DECODE	Failed to play WAV file.
2	- error -	MIX DISC	The disc has both WAV format files and audio CD format files on it.
3	- error -	TRACK	Playback is not possible because the file on the CD is of an unplayable format.

## Warning messages

When an operation cannot be conducted, one of the following pop-up warning messages will appear on the display. After appearing for about two seconds, warning messages automatically disappear.

	1st line	2nd line	Meaning
1	- caution -	NOT EXECUTE	Failed to execute the editing operation.
2	- caution -	CAN'T EDIT	Editing was not possible due to system limitations.
3	- caution -	CAN'T SELECT	Selection/execution was not possible due to system limitations.
4	- caution -	TRK PROTECT	Editing was not possible because the track is protected.
5	- caution -	NAME FULL	The maximum number of characters for the name (text field) has been reached.
6	- caution -	PROGRAM FULL	The track cannot be added because the maximum number of tracks in a program has been reached.
7	- caution -	SAME NAME	An item with the same name already exists.

## Operation messages

As necessary, the following messages will appear in the time display area.

	1st line	Meaning
1	CLOSE	The disc tray is closed.
2	DEVICE ERROR	The device cannot be detected. Please contact TASCAM customer support.
3	MEDIA ERROR	The media is not playback media.
4	MEDIA READING	Now reading from media.
5	NO MEDIA	Media is not loaded in the CD.
6	OPEN	The disc tray is open.
7	POWER ON	The system is starting up and initializing.
8	UNKNOWN	The media is in a format other than FAT. Format the media with the unit in order to use them together. The disc is an incompatible format (DVD, non-hybrid SACD, etc.). Use an audio CD, or data CD with WAV files.

# 10 – Troubleshooting

If the unit is not functioning properly, please check the following items before calling for service. If you are still unable to resolve the problem please contact the retailer where you purchased the unit or TASCAM customer support (see the back cover).

■ **Power does not turn on**

Confirm that the power plug is inserted completely.

■ **Media is not detected**

Confirm that the CD is loaded properly.  
Stop playback once.

■ **Unit cannot be controlled**

Confirm that the panel lock function is not on.

■ **Unable to playback a file**

If it is a WAV file, confirm that it uses a sampling frequency (44.1 kHz or 48 kHz) and a bit rate (16 or 24) that are supported by this unit.

■ **No sound**

Confirm the connections with the monitoring system and check the volume of the amplifier.

■ **Changed settings are not saved**

This unit backs up settings whenever you change them. This backup could fail if you turn off the power while this data is being written, so do not turn the power off immediately after changing a setting.

■ **I hear noise**

Check if any connecting cable might have a bad connection.

# 11 – Specifications

---

## Media and file formats

---

### Supported media

CD, CD-R (CD-DA audio discs, ISO9660 Level1/Joliet/Romeo data discs)

### Playback file formats

WAV: 44.1/48kHz, 16/24-bit

CD-DA: 44.1kHz, 16-bit

### Number of channels

2 (stereo)

1 (mono)

---

## Inputs and outputs

---

### Analog audio inputs and outputs

#### MIX INPUTS (BALANCED)

Connector: XLR-3-31 (1: GND, 2: HOT, 3: COLD)

Input impedance: 10 k $\Omega$

Nominal input level: +4 dBu (1.23 Vrms)

Maximum input level: +24 dBu (12.28 Vrms)

#### LINE OUTPUTS (BALANCED)

Connector: XLR-3-32 (1: GND, 2: HOT, 3: COLD)

Output impedance: 200  $\Omega$

Nominal output level: +4 dBu (1.23 Vrms)

Maximum output level: +24 dBu (12.28 Vrms)

#### MONITOR OUTPUTS (UNBALANCED)

Connector: RCA pin jack

Output impedance: 100  $\Omega$

Nominal output level: -10 dBv (0.32 Vrms)

Maximum output level: +6 dBv (2 Vrms)

#### PHONES

Connector: 6.3mm (1/4") standard stereo jack

Maximum output level: 45 mW+45 mW  
(THD+N 0.1%, 32  $\Omega$ )

---

## Digital audio output

#### DIGITAL OUT (COAXIAL)

Connector: RCA pin jack

Format: IEC60958-3 (S/PDIF consumer standard)\*

Output impedance: 75  $\Omega$

\*When the DIGITAL OUT TYPE in the SYSTEM menu is set to CONSUMER.

#### DIGITAL OUT (XLR)

Connector: XLR-3-31

Format: AES3-2003/IEC60958-4 (AES/EBU)\*\*

Output impedance: 110  $\Omega$

\*\*When the DIGITAL OUT TYPE in the SYSTEM menu is set to PRO.

---

## Control inputs and outputs

#### WORD IN

Connector: BNC

Input voltage: 5V TTL equivalent

Input impedance: 75  $\Omega$

Permissible frequency variation during external synchronization:  $\pm 100$  ppm

Switchable clock terminator

#### WORD THRU

Connector: BNC

Output voltage: 5V TTL equivalent

Output impedance: 75  $\Omega$

#### REMOTE IN (SERIAL)

Connector: D-sub 15-pin

#### REMOTE IN (PARALLEL)

Connector: D-sub 37-pin

Maximum input voltage: +5.5 V

High-level minimum input voltage: +3.75 V

Low-level maximum input voltage: +1.25 V

Output format: open drain (withstand voltage 50 V, maximum 100 mA)

Low-level maximum output voltage: 0.5 V

+5V power maximum supplied current: 100 mA

---

## Audio performance

---

#### Frequency response

20 Hz–20 kHz:  $\pm 0.5$  dB

#### Distortion

0.005% or less

#### S/N ratio

100 dB or more

#### Dynamic range

95 dB or more

#### Channel separation

95 dB or more

#### NOTE

*All audio performance ratings are for playback according to JEITA CP-2150 standards*

## Backup memory

The following settings are backed up even when the power is turned OFF.

- Playback mode settings
- Program playback settings
- Cue playback settings (for up to 500 CDs)
- Menu item settings: auto cue, auto ready, incremental playback, online back cue, play key function, monitor playback standby, online playback standby, repeat playback, EOM, end check, pitch control value, external remote, jog playback, RS-232C, digital output, analog output, online, master clock, mono mix playback, level meter display, fail safe, monitoring point, online monitor muting, display and indicator brightness, display contrast

## General

### Power

AC 100-240 V, 50-60 Hz

### Power consumption

14 W

### Dimensions (width × height × depth)

220 x 136.8 x 385.2 mm

### Weight

6 kg

### Operating temperature range

5–35° C (41–95° F)

### Installation angle

5° or less

## Dimensional drawings

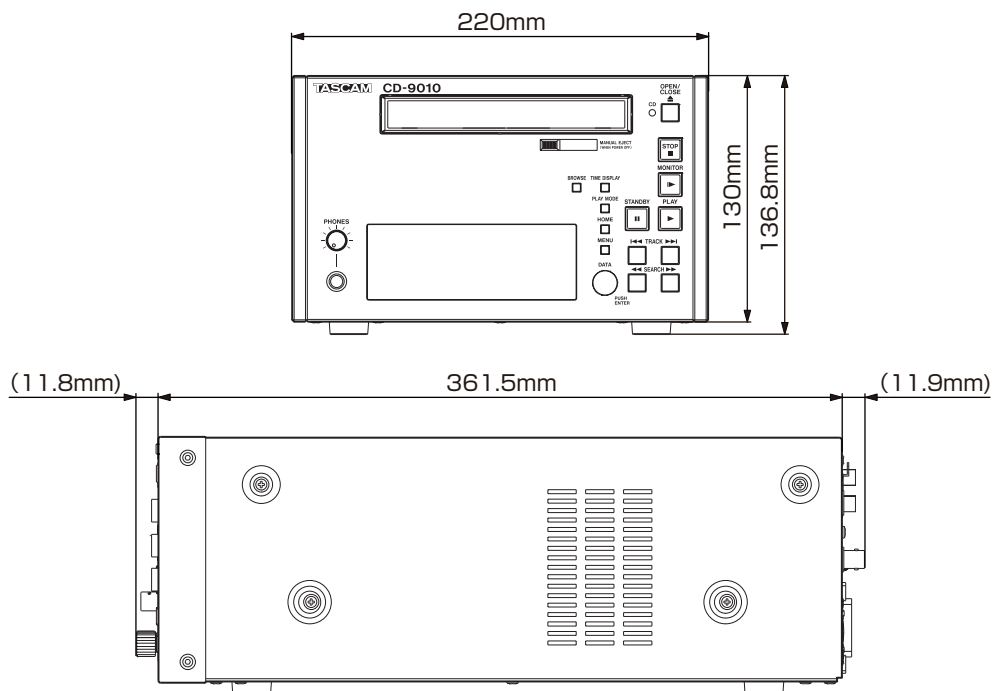

- *Illustrations in this manual might differ in part from actual products.*
- *In order to improve the products, specifications and appearance could be changed without prior notice.*

# TASCAM

# CD-9010

## TEAC CORPORATION

Phone: +81-42-356-9143  
1-47 Ochiai, Tama-shi, Tokyo 206-8530 Japan

[tascam.jp](http://tascam.jp)

---

## TEAC AMERICA, INC.

Phone: +1-323-726-0303  
7733 Telegraph Road, Montebello, California 90640 USA

[tascam.com](http://tascam.com)

---

## TEAC CANADA LTD.

Phone: +1905-890-8008 Facsimile: +1905-890-9888  
5939 Wallace Street, Mississauga, Ontario L4Z 1Z8, Canada

[tascam.com](http://tascam.com)

---

## TEAC MEXICO, S.A. de C.V.

Phone: +52-55-5010-6000  
Río Churubusco 364, Colonia Del Carmen, Delegación Coyoacán, CP 04100, México DF, México

[teacmexico.net](http://teacmexico.net)

---

## TEAC UK LIMITED

Phone: +44-8451-302511  
Suites 19 & 20, Building 6, Croxley Green Business Park, Hatters Lane, Watford, Hertfordshire, WD18 8TE, UK

[tascam.co.uk](http://tascam.co.uk)

---

## TEAC EUROPE GmbH

Phone: +49-611-71580  
Bahnstrasse 12, 65205 Wiesbaden-Erbenheim, Germany

[tascam.de](http://tascam.de)